

Love of life begins with "Rcom"

INSECT 140

Ver. 1.0

DIGITAL INSECT INCUBATOR USER'S MANUAL INSECT MAX 140







How to use Rcom Insect MAX 140

1. Introduction	
(1) Safety precautions	4 ~ 6
(2) Identification of Parts and Composition	
(3) Name & Function of Operation Parts	
2. Incubation	
(1) Incubation Start	7
(2) Incubation Termination	
3. Function Settings	
(1) Return to Factory Setting	7 ~ 9
(2) Temperature / Humidity Setting	
(3) How to turn ON/OFF Humidification function	
(4) Abnormal high, Low temperature alarm setting method	
(5) Daily Temperature Range(D.T.G) setting method	
(6) How to change Centigrade & Fahrenheit	
4. How to Clean	
(1) Disassembling and Cleaning the Incubator	10 ~ 11
5. Product Information	
(1) Troubleshooting	12 ~ 14
(2) Specification	

Introduction
Incubation
Function Settings
How to Clean
Product Information

⚠ The result of Hatching and Brooding can be changed by a large numbers of factors. Autoelex Co., Ltd. & our distributors will not take any responsibility for ‘Loss of eggs or pet/animal lives’ under any circumstances such as ‘Hatching/Brooding failures’, ‘User’s carelessness’, ‘Personal (un-certificated) conversion / alteration’, ‘Arbitrary using out of the machine’s purpose’, ‘Electric power failure’, or ‘Malfunctioning’. Please be sure that the machine works without any problem before placing Eggs or Pets(Animals). Also, we strongly recommend you to read the User’s Manual carefully to minimize of any failure.

Mark Explanation

	Caution : Caution mark against a fault that can cause damage, trouble, or failure of incubation.
	Prohibited.
	Do not disassemble.
	Do not touch.
	It is necessary to keep.
	Remove the power cord from outlet.
	Ground Connection for preventing electric shock.
	Tip : References or useful suggestions in using Rcom product
	CAUTION Warning of actions which may be dangerous or cause damage to the incubator.

1. Introduction

(1) Safety Precautions

INSECT 140

Electrical hazards

CAUTION Be careful the details below when you use.

Do not use a damaged power cord or loose outlet. ▶ Risk of electric shock or fire.	Do not pull the cord when taking out the power cord, and keep wet hands away from connecting plug. ▶ Risk of electric shock or fire.	Never pull the plug out of the outlet during the incubation period. ▶ Incubation will be interrupted.	Do not twist or crush electric cord. ▶ Risk of electric shock or fire.	Do not insert multiple connecting plugs in an outlet. ▶ Risk of fire or electrical overload.

Setting Cautions

CAUTION Be careful the details below when you use.

Do not install in dusty or dirty environment. ▶ Risk of damage or fire within the incubator.	Do not install under the direct sunlight. ▶ Risk of fire or interference with the incubation process.	Do not install in moist or humid environment. ▶ Risk of fire or electric shock.	Do not install in excessively cold or hot conditions, cigarette smoke, etc. ▶ Risk of interference with the incubation process.	Do not use any other non-standard parts except those provided. ▶ Risk of damage or hatching failure.
Do not cover the ventilating opening. ▶ Inner temperature can rise, interrupting incubation.	Install away from heat sources. ▶ Risk of damage to the incubator case and interference with the incubation process.	Ensure that the incubator is installed on a stable surface away from edges. ▶ Risk of damage to incubator and eggs and user from accidental knocks or drops.	Do not turn the incubator upside down. ▶ Water will pour out of the incubator, and view window can be dropped or damaged.	Children should be supervised to ensure that they do not play with the appliance.
Do not disassemble or modify the incubator in any way. ▶ Risk if electric shock or fire.	Please ensure that no small objects get into the holes on the incubator. ▶ Risk of electric shock or fire.	If the incubator sounds strange or emits smoke contact your service center. ▶ Risk of electric shock or fire.	Clean the incubator thoroughly before storing.	If the incubator requires repair disconnect from the power supply and please contact to your service center.

Cleaning Cautions



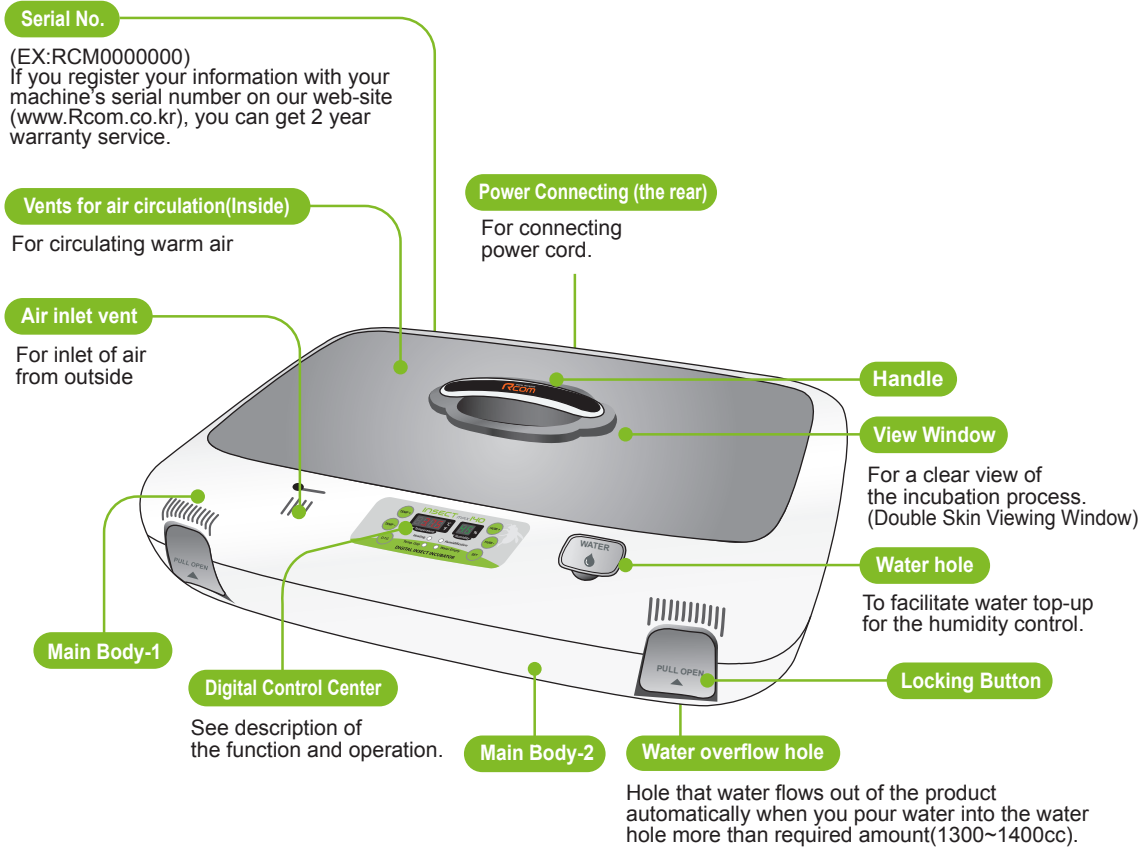

CAUTION Be sure to disconnect the electric cord from the outlet before cleaning.

Do not spray cleanser directly on the incubator surface.	Clean the incubator by a soft cloth with a neutral detergent.	Brush away dust on the plug with a dry cloth.	Do not use chemicals like wax, benzene, alcohol, thinner, aromatic, or lubricant, etc.	For special cleaning of inner part per year, contact to the service center. ▶ If you don't clean the inside of incubator for a long time, dust can cause some trouble or a fire.

Identification of Parts



Incubation room? It means the place where the incubator is installed and operated, and as it has much effect on incubation rate according to the environment of incubation room, it is good to install incubator at the place where there is little noise and vibration in the vicinity and the temperature range isn't severe in the temperature of 22~25°C (71.6~77°F). In particular, as there are many cases that the temperature falls rapidly in the nighttime differently from the daytime, it is necessary to check certainly, and during daytime, incubator must not be exposed directly to the sunlight.

-  Before inserting eggs, please start incubation after checking if all functions work without any problem by operating incubator sufficiently.
-  In case that sight glass and water cap weren't closed completely, temperature and humidity aren't normally operated. Therefore, please be careful.
-  In case of moving with water filled, as it may cause a breakdown, fill water after installing it at the place where you want to incubate.
-  Please be careful not to give any heavy power or shock on the heater part for humidification in the upper side of main body as it may be a cause of breakdown. Some foreign substance is created on the heater part after use, however, there isn't any problem caused of it. (See cleaning method)

1. Introduction

(3) Name & Function of Operation Parts



Name & Function of Operation Parts

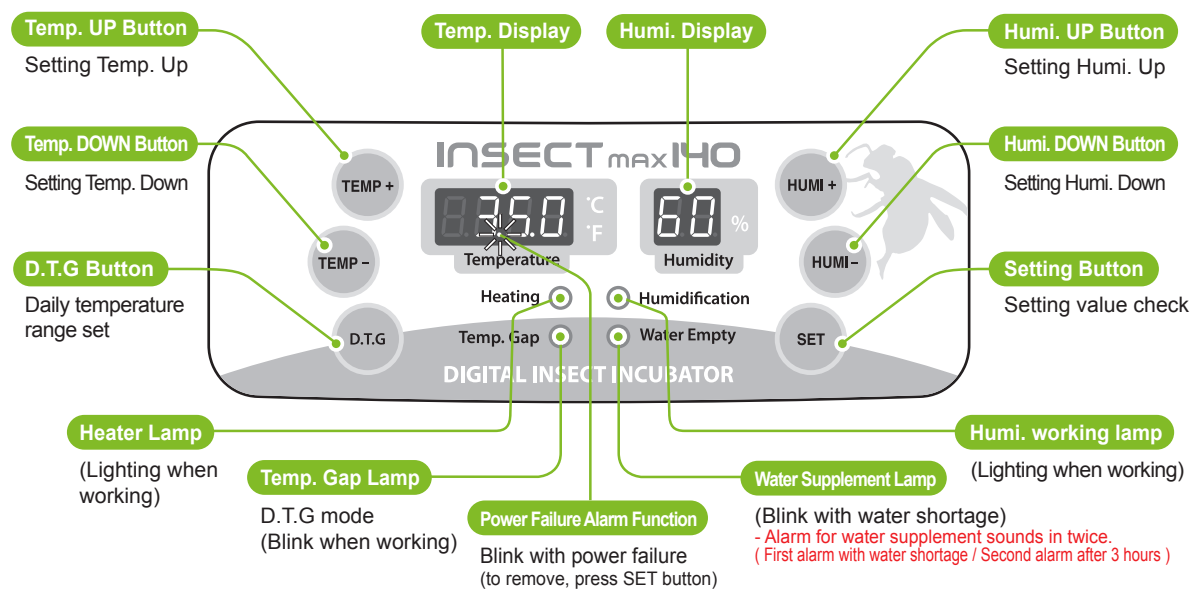

Tip What's 'Temperature & Humidity Setting'? This is that you set up temp. & humi. As you want to have inside of the machine.

[Function Operation & Explanation] ※ If you want to change setting value, keep pressing "SET" button and change the value.

Function	How to Operate	Explanation
Temp. Setting	SET HOLD ▶ TEMP+ or TEMP-	Setting of needed temp.
Humidity Setting	SET HOLD ▶ HUMI+ or HUMI-	Setting of needed humidity.
Daily Temp. Gap (D.T.G) set	SET HOLD ▶ D.T.G	D.T.G ON / D.T.G OFF (one time a day for 3 hours + 1.5°C operation)
Changing Cels. & Fahr.	TEMP+ + TEMP- HOLD ▶ CA ▶ SET	Changing Cels. & Fahr.
Initialization (Factory setting)	SET HOLD + POWER IN ▶ rSt	Initialization
How to OFF Humidification Function	SET + HUMI- ▶ below 40%	In case of incubation at low humidity

INSECT 140

**2. Incubation
3. Function Settings**

**(1) How to Start Incubation
(2) Incubation Termination
(1) Return to Factory Setting**

How to Start Incubation

- ▶ Connect power cord of incubator to start incubation into the temperature and humidity set in the past.
[In case of initial shipment, temperature 35.0°C (95°F), humidity RH 60%]
- ▶ Set proper temperature and humidity of species to be incubated to start incubation. It is necessary to pass some period to be stabilized into set temperature and humidity.

Tip There can be some odor the first time you use incubator, which is normal.

Tip Power Failure Notification : When firstly input power, or power failure during incubation, second dot "." of temp. display is blink with alarm. Press SET to remove.

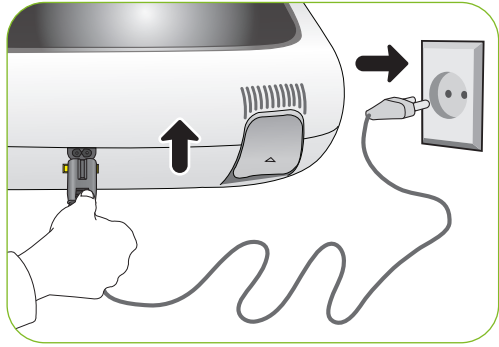

※ The artificial intelligence system memorizes and classifies ambient conditions for keeping optimum temperature, and temperature can move up slowly at the first stage.

Incubation Termination

- ▶ After all eggs are hatched, you should REMOVE the power cord for incubation termination.
(The incubator has no separate power switch.)
- ▶ In case of neglecting it after turning off incubator during incubating at high humidity, the water leaving in the inside evaporates and may create water drops on the FND window and control equipment. In order to prevent this, separate the up and down of main body to dry it. (it may be possible to operate incubator for 1~2 hours and dry its inside after removing the water for humidification of incubator inside.)

Return to Factory Setting

- ▶ It is for returning to the factory default setting.
- ▶ It is for initializing the incubator setting or calibration to the factory settings when you handle the incubator improperly so that the value has changed. Unplug the power supply and hold SET button and re-plug the power supply as shown on picture. Then, rSt will show on the display, and the incubator will be initialized to factory setting.

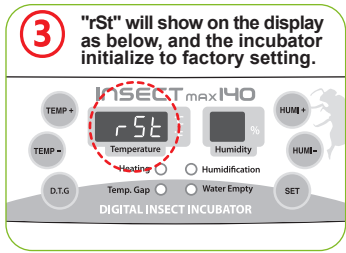
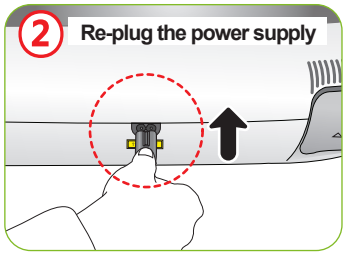
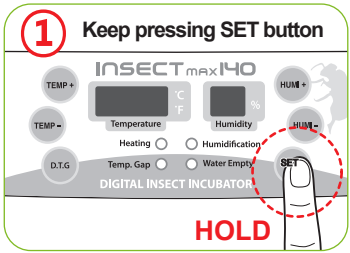

3. Function Settings

(2) Temp. / Humi. Setting
(3) How to turn ON/OFF Humi. function

INSECT 140

Temperature Setting

▶ Press **TEMP+** button or **TEMP-** button pressing **SET** button to adjust into wanted temperature. Take hands off from SET button to complete temperature setting and display the temperature of present incubator inside.

Tip In case of installing incubator at the place where direct light lights or its surrounding temperature is too low, it may be higher or lower than set temperature.

Tip Press **SET** button to display set temperature and humidity and take hands off to display present temperature and humidity of incubator inside.

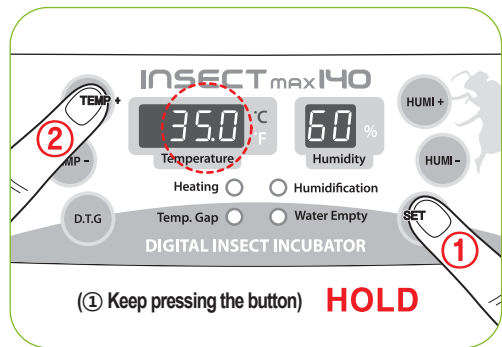

Humidity Setting

▶ Press **HUMI+** button or **HUMI-** button pressing **SET** button to adjust into wanted humidity. Take hands off from SET button to complete humidity setting and display the present humidity of incubator inside.

Tip The temperature or humidity of incubator is out of set range according to the surrounding environment (incubation room), there may be some difference.

! Temperature and humidity is optimized when Rcom products are released. We do not recommend customers to recalibrate by their own. If you need to recalibrate, please visit our website (www.Rcom.co.kr→Download→Manual) or ask purchase place. Because of low price thermometers and hygrometers are not accurate, we recommend you to use special calibrated thermo-hydrometer. (Poultry only thermo-hydrometer: check Rcom website)

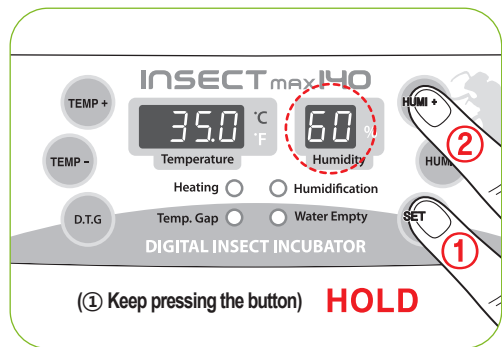

How to Turn ON/OFF Humidification Function

▶ Continue to press **HUMI-** button pressing **SET** button until "OFF" is displayed to turn off humidifying function.

▶ Press **HUMI+** button pressing **SET** button to set humidity into over RH 30%. Then, its humidifying function is on.

! In case of using without putting water for humidification in or incubating at low humidity of less than RH 30%, it is necessary to stop humidifying function. In case of not supplying water for humidification turning on humidifying equipment, the humidifying unit part is damaged or the lifespan of part is shorten noticeably. Be sure to turn OFF humidifying function equipment.

Abnormal high, Low temperature alarm setting method

▶ What is abnormal alarm function? It is an alarm function notifying it to user in case that the temperature of incubator inside raised or decreased abnormally.



- * Max. abnormal temp. alarm limit [0.0 ~ 5.0°C (0 ~ 9°F) Default Setting : 0°C]
- * Min. abnormal temp. alarm limit [0.0 ~ -5.0°C (0 ~ -9°F) Default Setting : 0°C]

Daily Temp. Range(D.T.G) setting method

▶ Press (D.T.G) button pressing (SET) button to turn on TEMP. GAP lamp and turn ON daily temperature range. And turn off run lamp to turn OFF daily temperature range. [Default Setting : OFF]

▶ Daily temperature range (D.T.G)? It is a function artificially making the highest time zone of temperature by sun at the natural condition, and it is a function that can raise the incubation success rate of the optimal incubation environment by raising temperature at the fixed time zone.

Tip When D.T,G function operates, TEMP. GAP lamp flickers. D.T,G function is 1.5°C (2.7°F) higher than the existing set temperature once a day for 3 hours.

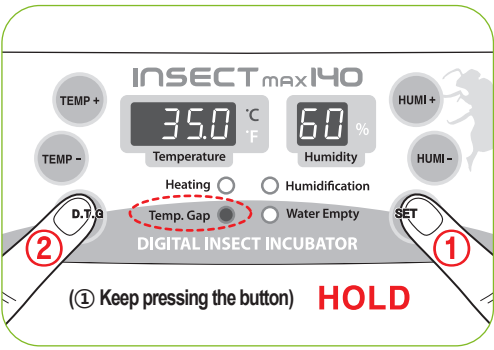

How to change Cels. & Fahr.

▶ Press (TEMP+) button and (TEMP-) button at the same time and press (SET) button at the state that CA was displayed on temperature display window to change it.

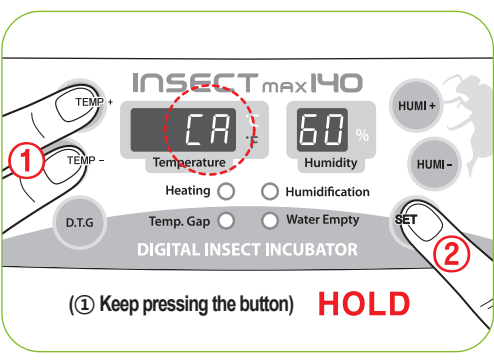
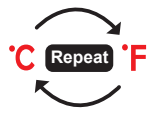

4. How to Clean

(1) Disassembling and Cleaning the Incubator

INSECT 140

Disassembling and Cleaning the Incubator

- ▶ Pull out the electric cord from the connecting jack and also take out the plug from the outlet.

! In case of turning off the power immediately after using incubator, it may be a cause of breakdown because of the humidity remaining in the inside of main controller. Then, it is necessary to turn it off after operating about for 1 hour at the state of removing water for humidification of the incubator inside or reoperate it after opening sight glass and naturally drying for 2~3 hours in order to use machine for a long time.

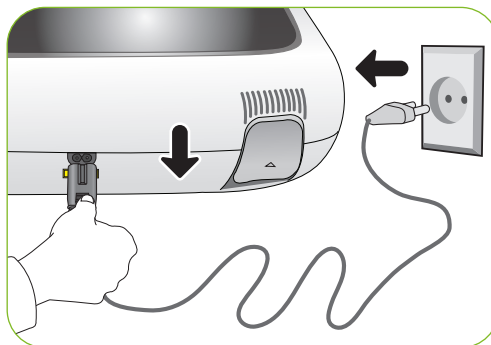

Unlock and remove the locking buttons for four parts at the front and back of incubator by pulling them forward.

Dry main body(bottom) and tray after washing with water cleanly and dry main body(up) about for one day at airy area in order to remove remaining humidity in the inside completely.

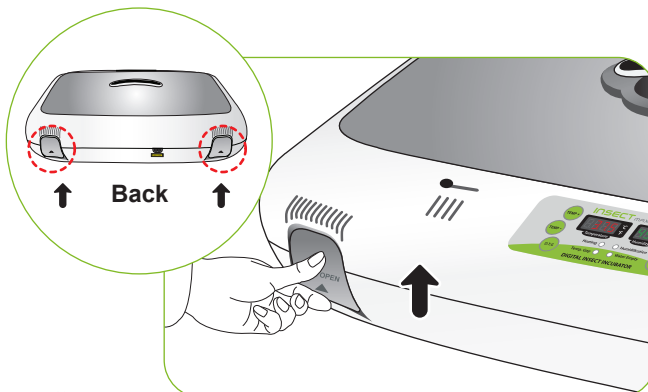

- ▶ When using humidification function, a lot of alien matter sticks to the humidification heating element (a). This may not cause failure, but when terminating incubation please clean the humidifying heater lightly with a soft brush.

Tip In case of using distilled water as water for humidification, it is possible to reduce foreign substance(scale) noticeably.

- ▶ If you place the main body(upper part) on the floor, please don't let the humidification heating part touch with the floor.

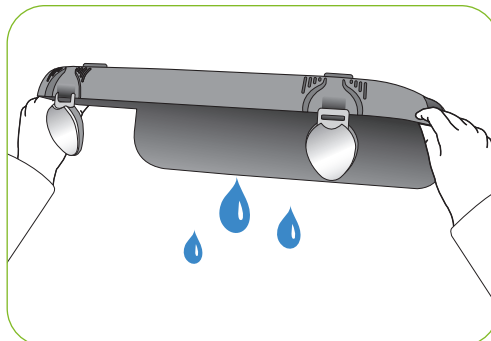

! In case of giving some shock on the heater part (a) for humidification or drawing it with a sharp thing, the heater for humidification is damaged.

! In order to reduce foreign substance(scale) of the heater part (a) for humidification, it is recommendable to use distilled water as water for humidification. In case of wanting to use other water, be sure to use it after inquiring to the store purchased.

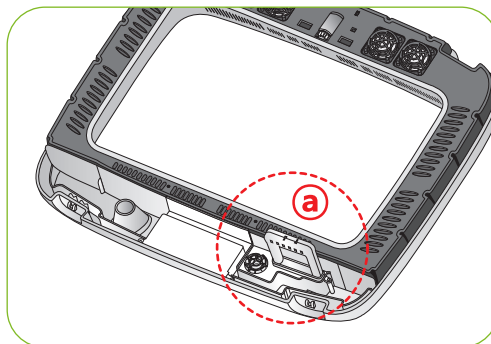

INSECT 140

4. How to Clean

(1) Disassembling and Cleaning the Incubator

Start the vacuum cleaner to remove the dust as shown on the right and thoroughly shake out the minute dust with a fine brush.

Tip If the incubator goes through incubations several times, dust, shell, etc. accumulate inside the main body, which may cause a break down, so be sure to clean the product before storage.

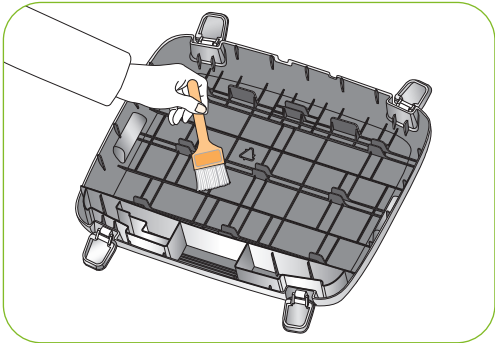

Warning In case the incubator clean status is poor which may cause fan noisy or stopping.

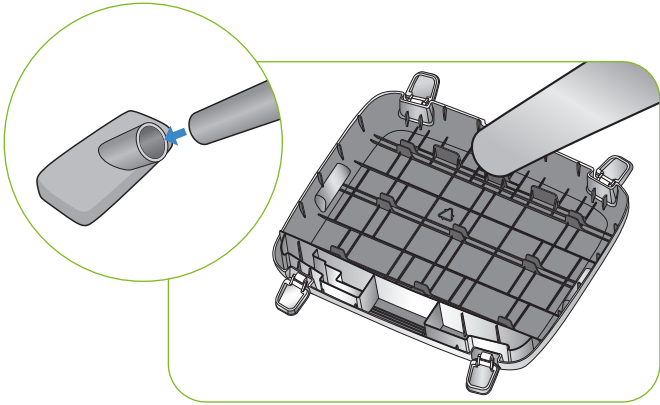

If you finish cleaning the incubator, reassemble it in the reverse order of disassembly. Wipe out outside the main body with a wet cloth and dry it in a cool and well-ventilated place before storage.

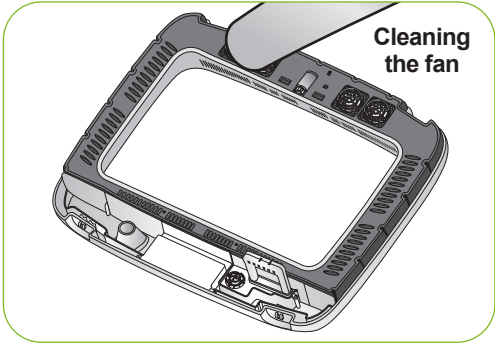

Warning Don't clean the product with organic solvents such as benzene, thinner, etc. which may cause deformation or decoloration.

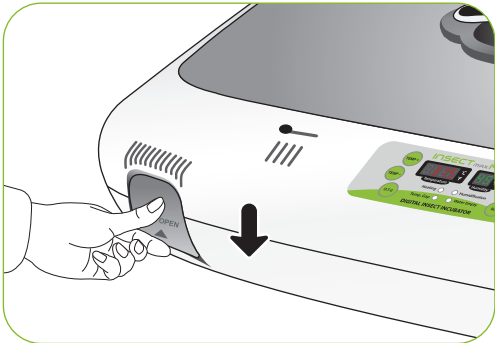

Troubleshooting

All our Rcom digital products of Autoelex Co., Ltd. are made by precision systems under strict quality control. But occasionally some defective products are found on the way of their distribution. If any problem occurs, then please contact Autoelex service center or distributors in your country. We will do our best to solve the problems, if any, for you. This product is designed in modular mode, so for its repair, if any, a qualified person can replace the part concerned with ease.

Troubles	Expected Causes (Possibility)	Countermeasures
No signs of power to the incubator.	<ul style="list-style-type: none"> ▶ Check if power cord was connected well. ▶ Check power failure. ▶ Check if plug is defective. 	<ul style="list-style-type: none"> ▶ Try to plug-in again. ▶ Check other electric and electronic product nearby. ▶ Check after moving to other socket.
When temperature is too high / When temperature is too low	<ul style="list-style-type: none"> ▶ Check set temperature. ▶ Check if FAN for air circulation doesn't rotate. ▶ Try to make factory initialization. [See 7 page] 	<ul style="list-style-type: none"> ▶ Adjust set temperature to wanted temperature. ▶ Unplug from socket and separate main body to clean FAN area for air circulation with a brush or writing brush.
When humidity is too high / when humidity is too low	<ul style="list-style-type: none"> ▶ Try to make factory initialization. [See 7 page] <p><When low></p> <ul style="list-style-type: none"> ▶ Check if sight window closed well. <p><When high></p> <ul style="list-style-type: none"> ▶ Check surrounding environment. ▶ Check if tray inside or main body(bottom) contains water. 	<ul style="list-style-type: none"> ▶ Refill water sufficiently. <p><when low></p> <ul style="list-style-type: none"> ▶ Check if foreign substance was inserted and close it again. <p><when high></p> <ul style="list-style-type: none"> ▶ Adjust environment of incubation room. [See 5 page]
The machine makes some noise. It is normal that the machine emits some sounds because it uses air circulation fan for working.	<ul style="list-style-type: none"> ▶ Check if there is some other object on the incubator. ▶ Check if there is some vibration on the floor or it was installed on the desk. ▶ Check if some foreign substance was attached to FAN area after incubation. 	<ul style="list-style-type: none"> ▶ Remove all the objects put on the incubator. ▶ Move incubator to the safe place to install. ▶ Unplug from socket and separate main body to clean FAN area for air circulation with a brush or writing brush.
Water leaks from the machine. * In case of keeping at high humidity, there may be some dew.	<ul style="list-style-type: none"> ▶ As incubator operates at high humidity, there is some dew on the sight window. It isn't a breakdown but natural phenomenon. 	<ul style="list-style-type: none"> ▶ Please install within the condition of incubation room.

 **Before inserting eggs, please start incubation after checking if all functions work without any problem by operating incubator sufficiently.**

Specification

1-1 Name : Rcom Insect MAX 140

1-2 Model : MX-N140

Power	AC 100~120[V], 50/60[Hz] AC 220~240[V], 50/60[Hz]		
Temp. Control Range	20 ~ 42[°C] / 68 ~ 107.6[°F]	Outside Environment Temp.	Optimal range : 22 ~ 25[°C] / 71.6 ~ 77[°F]
			(Low) 20[°C] / 68[°F] (High) 26[°C] / 78.8[°F]
Humi. Control Range	40 ~ 95[%] (It can be changed according to the conditions)		
Temp. and Humi. accuracy	±0.5[°C], ±0.9[°F] / ±5[%]		
Capacity	140[eggs] (Different from the species of egg)		
Power Consumption	Average 65[W] Max. 120[W]		
Product Weight	6.65[Kg]		
Product Size	(W)633×(L)523×(H)171[mm]		
FUSE Standard	250[V] 2.0[A] (Ø5*20[mm])		

Register your product Serial No. on our website for free 2 years gurantee.
Refer to website for how to register. (Free 1 years gurantee in case not registerd.)

※ Product Registration Procedures

If you are a new member of Rcom, you need to log in our website at www.Rcom.co.kr

1. Click "SIGN UP" on top of the right corner.
2. Fill out the information on the blanks.

If you already registered your information on the Rcom website, please log in

1. Click "Login" on top of the right corner.
2. Select "Customer" and click "Register Products".
3. Fill out the information on the blanks.

You will need below information to register on our website.

1. Your name
2. Your (home/company) address & Email address, country
3. Your product(model) name & Serial number
4. Date of purchase & Name of purchased shop you bought from



Rcom Incubator Series

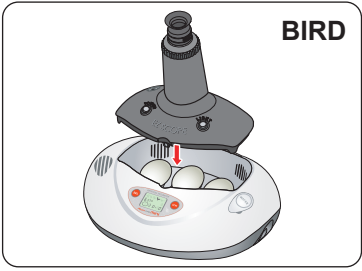

BIRD

Rcom PRO MINI Package (PX-03S)

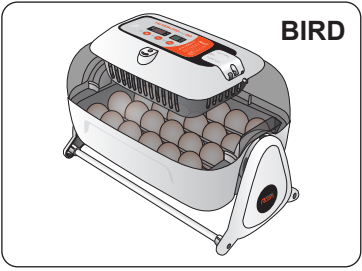

BIRD

Rcom KINGSURO MAX 20 (MX-SURO)

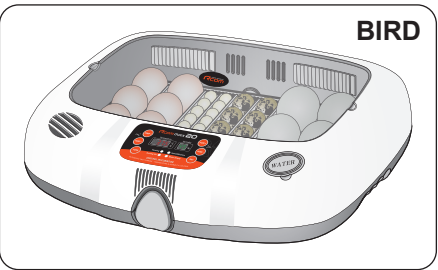

BIRD

Rcom MAX 20 (MX-20)

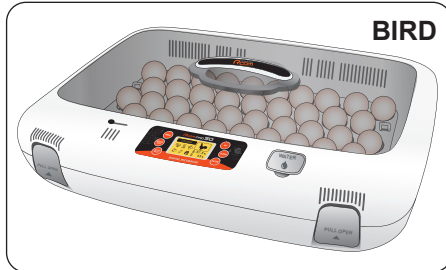

BIRD

Rcom PRO 50 (PX-50)

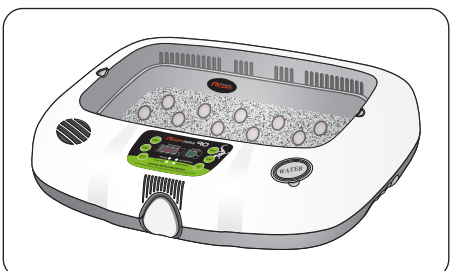

Rcom REPTILE MAX 90 (MX-R90)

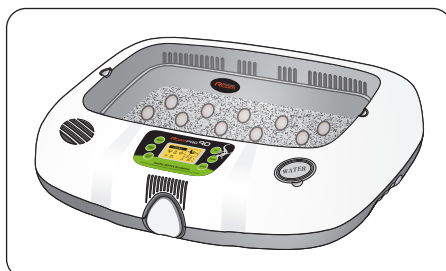

Rcom REPTILE PRO 90 (PX-R90)



Rcom REPTILE MAX 230 (MX-R230)

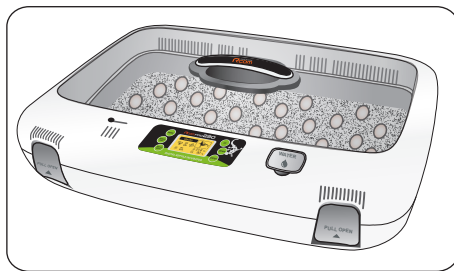

Rcom REPTILE PRO 230 (PX-R230)

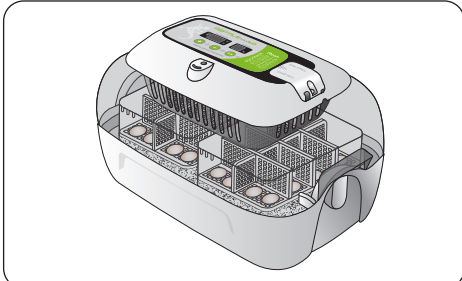

Rcom REPTILE MAX 60 (MX-R60)



Rcom DIGILOG (PX-V1)



Rcom DIGILOG2 (PX-V2)

It is possible to check additional information at Rcom homepage (www.R-com.co.kr).

Rcom is designed for user's easy and convenient use.
It can be changed without notice for improvement in performance,
design,treatment, and software, etc.



<https://www.r-com-hatcher.com>



North America Sales & Service

<https://www.r-com-hatcher.com>

MANUFACTURER

AUTOELEX CO.,LTD.
● OFFICE : 218, Sangdong-ro, Sangdong-myeon,
Gimhae-si, Gyeongsangnam-do, 50805 Korea

Rcom is the Best Design with High Quality, Value, and Performance!