

Love of life begins with "Rcom"

20

REV. 4.0

DIGITAL EGG INCUBATOR USER'S MANUAL

USB 20 / PRO 20



Rcom



How to use Rcom USB 20 / Rcom PRO 20

1. Introduction

(1) Rcom USB, PRO 20 Introduction	4
(2) Safety Precautions	5
(3) Identification of Parts	6
(4) Basic Components	7
(5) Function of Digital Control & How to Operate	8
(6) SET UP(Other Functions) / Easy Function Operation	9

Introduction

2. Before use

(1) How to Assemble the Incubator / Egg-Turning plate	10
(2) What is an incubation room? / Preparation for Incubation	11~12

Before use

3. Function Settings

(1) Incubation Modes / Incubation start with Automatic Mode	13
(2) Incubation start with Manual Mode	14~15
(3) Incubation start for Other Birds	16
(4) Incubation start with PC connection Mode	17
(5) Incubation Termination / Change Cels.& Fahr. / Return to Factory Setting	17
(6) Incubation conditions reset / How to Set Egg Turning Test / How to Set Turn ON, OFF Humidification Function	18

Function Settings

4. Other Functions

(1) Egg Turning Check / Alarm for water supplement / Abnormal High or Low temperatue Alarm / Power Failure Alarm Function	19
---	----

Other Functions

How to use Rcom USB 20 / Rcom PRO 20

5. Incubation	
(1) Humidity & Air Maintenance during Incubation / Maintenance after Hatching	20
(2) Dew Condensation	20
6. How to Clean	
(1) How to Disassemble	21
(2) How to Clean	22
7. Product Information	
(1) Servicing / Frequently Asked Questions (FAQ)	23
(2) Troubleshooting	24
(3) Specification	25

Introduction
How to Clean
Product Information

! The result of Hatching can be changed by a large numbers of factors. Autoelex Co., Ltd. & our distributors will not take any responsibility for 'Loss of eggs or pet/animal lives' under any circumstances such as 'Hatching/Brooding failures', 'User's carelessness', 'Personal (un-certificated) conversion / alteration', 'Arbitrary using out of the machine's purpose', 'Electric power failure', or 'Malfunctioning'. Please be sure that the machine works without any problem before placing Eggs or Pets(Animals). Also, we strongly recommend you to read the User's Manual carefully to minimize of any failure.

Mark Explanation



Caution : Caution mark against a fault that can cause damage, trouble, or failure of incubation.



Prohibited



It is necessary to keep.



Do not disassemble.



Remove the power cord from outlet.



Do not touch.



Ground Connection for preventing electric shock.



Tip : References or useful suggestions in using Rcom product



Warning of actions which may be dangerous or cause damage to the incubator.

▶ For Rcom USB 50 MODEL PC connecting, refer to the PC-SOFTWARE manual.

Rcom 20

Thank you for choosing the Rcom incubator.

The Rcom 20 incubator is the first incubator with creditability to have a superior design and function which help in controlling optimum incubation conditions. It has two sensors, one for detecting surrounding environments and the another for internal incubator conditions.

The Rcom20 is designed easy to use and simple to use as a customer orientated product, but please remember that the user's incubation knowledge and proper operation are very important for the best incubation result. Therefore, be sure to read this user's manual carefully before you use this incubator.

The Rcom 20 offers optimum incubation conditions, but users need to observe and manage all incubation conditions such as species of eggs, temperature or humidity for each incubation period, and an optimum incubation circumstances .

Features

[Main Features]

- * LCD display with incubation information, and animation graphic design
- * Micro chip with optimum incubation conditions according to the species of birds, for incubation beginners
- * Manual setting Mode for incubation specialists
- * Outer Temp. Sensor included for Automatic Adjustment of Heating rate responding to Incubation Room Temperature
- * Superior design with convenient operation
- * Optimum air circulation technique with 3 strong BLDC fans
- * Automatic Temp. & Humidity setting and control
- * Body locking device
- * Water supplement alarm function
- * 20 eggs capacity for chicken size eggs (52 Quail egg size / 10 Goose egg size)
- * Antiblastic Humidification method by heating water, which discourages bacterial growth
- * Double-glazed view window for minimizing the influence of outside temperature
- * Enhanced reliability by applying Swiss's Sensirion's 3rd generation temperature & humidity sensor
- * Strong SMPS application for stable power supply
- * Upgrade to the latest model incubator with program upgrade (USB MODEL ONLY)

[Safety Features]

- * Self-examination function for sensing abnormal conditions
- * Alarm and display function for abnormal incubator temperature caused by sudden fluctuation of ambient temperature
- * Incubation data memory function and power outage notification function in case of power failure
- * Circulation fan cover for safety and electric safety cut-out switch on the upper main body for safety
- * Heater supporter designed for heater tension control and its safety
- * Safety cover applied for protecting humidification unit
- * Humidification unit durability improved by water proof BLDC fan
- * Alarm when water need replenishing

[Easy Features]

- * No need of separate humidification unit as it included in main body
- * °C or °F convertible
- * Various kinds of egg trays accept various sized eggs with ease
- * Slide plate with embossed feature for preventing skid
- * Variable air vent for adjusting air supply
- * Bottom body designed for easy cleaning
- * Roller Dividers, which can safely apply egg turning for expensive or rare eggs. (Option)

Electrical hazards

CAUTION Be careful the details below when you use.

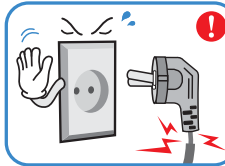

Do not use a damaged power cord or loose outlet.

▶ Risk of electric shock or fire.

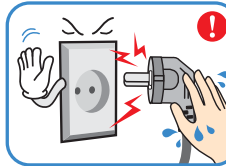

Do not pull the cord when taking out the power cord, and keep wet hands away from connecting plug.

▶ Risk of electric shock or fire.

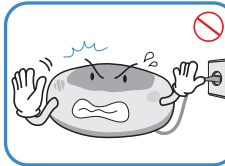

Never pull the plug out of the outlet during the incubation period.

▶ Incubation will be interrupted.

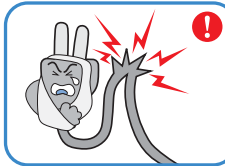

Do not twist or crush electric cord.

▶ Risk of electric shock or fire.

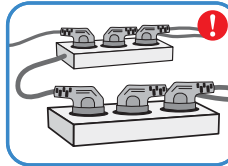

Do not insert multiple connecting plugs in an outlet.

▶ Risk of fire or electrical overload.

Setting Cautions

CAUTION Be careful the details below when you use.



Do not install in dusty or dirty environment.

▶ Risk of damage or fire within the incubator.

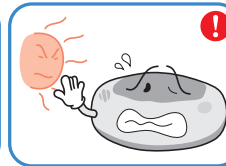

Do not install under the direct sunlight.

▶ Risk of fire or interference with the incubation process.

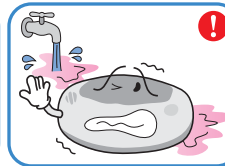

Do not install in moist or humid environment.

▶ Risk of fire or electric shock.



Do not install in excessively cold or hot conditions, cigarette smoke, etc.

▶ Risk of interference with the incubation process.

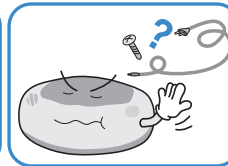

Do not use any other non-standard parts except those provided.

▶ Risk of damage or hatching failure.

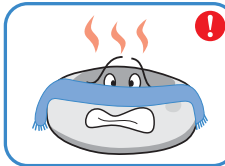

Do not cover the ventilating opening.

▶ Inner temperature can rise, interrupting incubation.

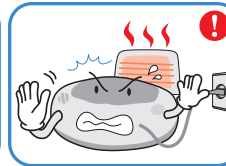

Install away from heat sources.

▶ Risk of damage to the incubator case and interference with the incubation process.



Ensure that the incubator is installed on a stable surface away from edges.

▶ Risk of damage to incubator and eggs and user from accidental knocks or drops.



Do not turn the incubator upside down.

▶ Water will pour out of the incubator, and view window can be dropped or damaged.

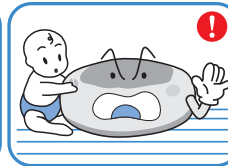

Children should be supervised to ensure that they do not play with the appliance.

▶ Risk of knocking the incubator or accidental interference with the controls.

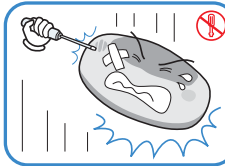

Do not disassemble or modify the incubator in any way.

▶ Risk of electric shock or fire.

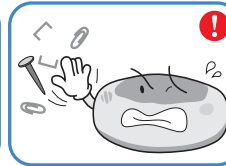

Please ensure that no small objects get into the holes on the incubator.

▶ Risk of electric shock or fire.

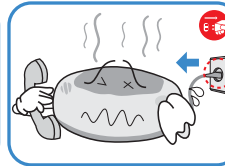

If the incubator sounds strange or emits smoke contact your service center.

▶ Risk of electric shock or fire.



Clean the incubator thoroughly before storing.

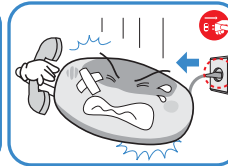

If the incubator requires repair disconnect from the power supply and please contact to your service center.

Cleaning Cautions

CAUTION Be sure to disconnect the electric cord from the outlet before cleaning.

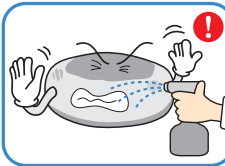

Do not spray cleanser directly on the incubator surface.



Clean the incubator by a soft cloth with a neutral detergent.

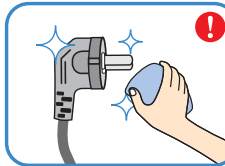

Brush away dust on the plug with a dry cloth.

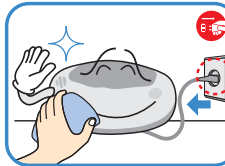

Do not use chemicals like wax, benzene, alcohol, thinner, aromatic, or lubricant, etc.

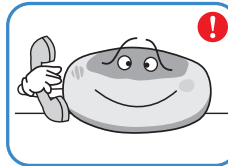

For special cleaning of inner part per year, contact to the service center.

▶ If you don't clean the inside of incubator for a long time, dust can cause some trouble or a fire.

Identification of Parts

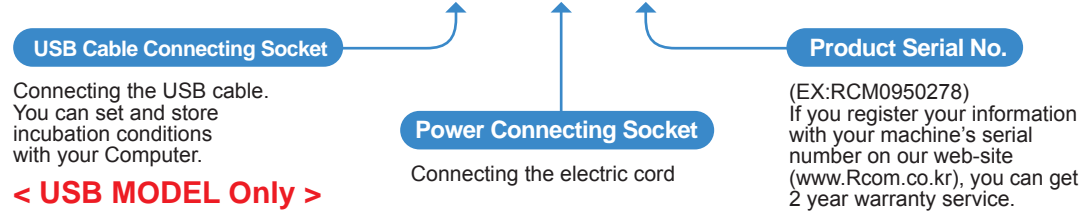
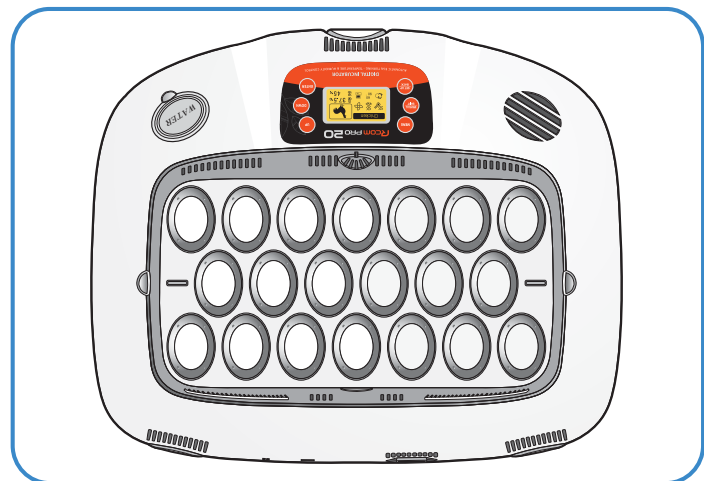
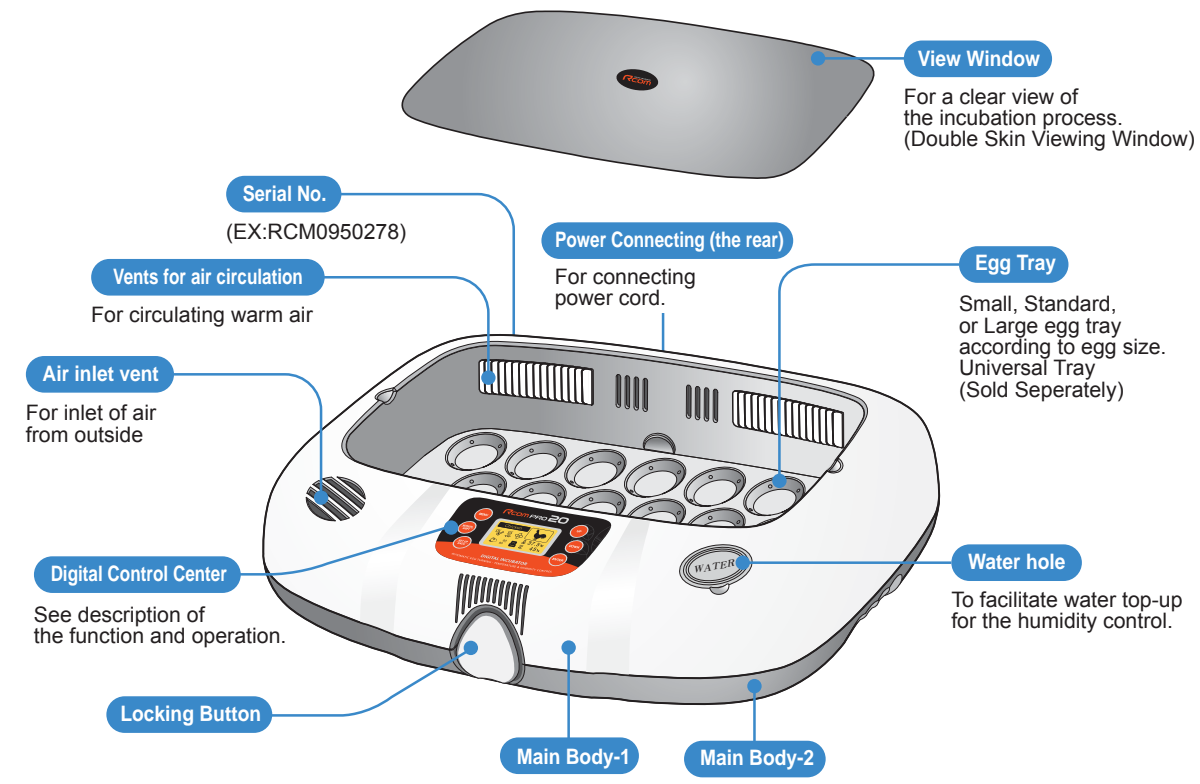

Basic Components

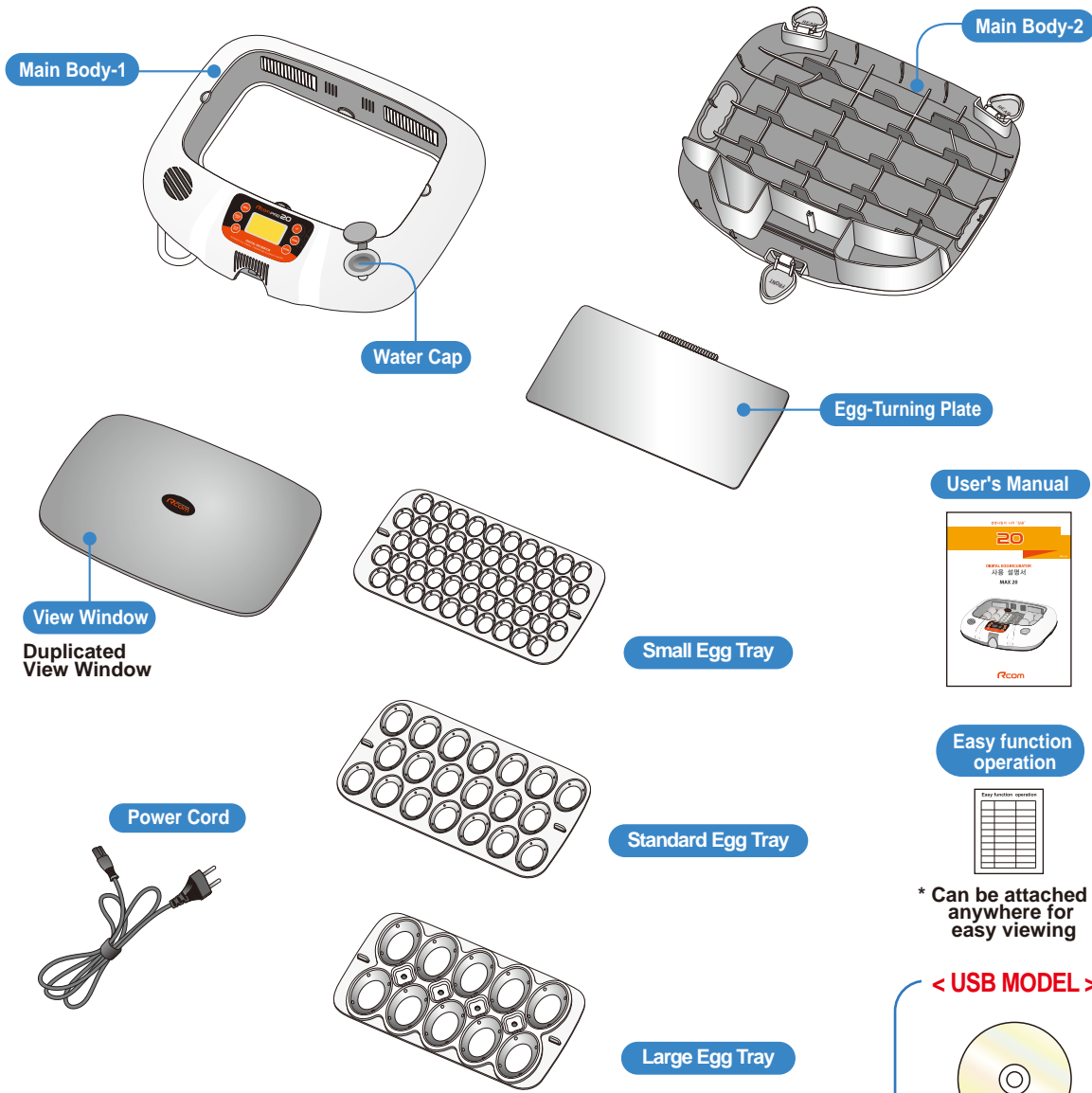

Sold Separately

<p>Universal Tray Divider(10EA)</p>	<p>Rolling Divider SET</p>
<p>Universal Tray SET</p>	<p>Rolling Divider SET</p>

< USB MODEL >

PC SOFTWARE CD

USB Cable

* Can be attached anywhere for easy viewing

► **USB MODEL** - You can download updated information at www.RcomCo.com

Function of Digital Control & How to Operate

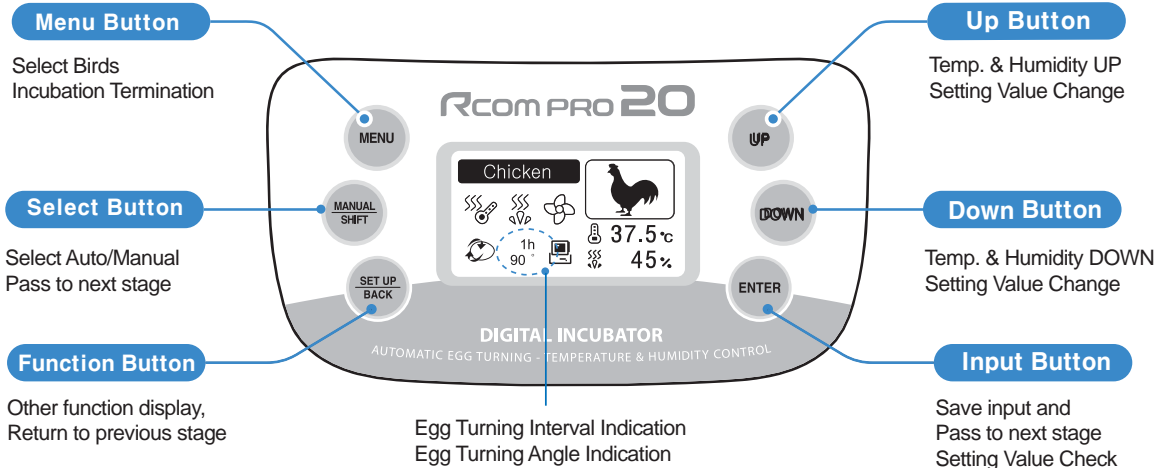

What's 'Temperature&Humidity Setting'?

This is that you set up temp.&humi. As you want to have inside of the machine.

ICON	NAME AND FUNCTION	ICON	NAME AND FUNCTION
<p>Bird Icon Display</p>	<p>**Choose a kind**</p> <ul style="list-style-type: none"> * Chicken ① * Duck ② * Quail ③ * Pheasant ④ * Peafowl ⑤ * Goose ⑥ * wildgoose ⑦ * G-Pheasant ⑧ * Turkey ⑨ * Others Birds ⑩ 		<p>Egg Turning Indication</p> <p>Manual Egg Turning Stop Indication</p> <p>Automatic Egg Turning Stop Indication</p> <p>Incubation Termination</p>
	Species of Birds		FAN Operation Display
37.5°C	Current Temperature Display Temperature Abnormal Display		Heater Stop Display Heater Operation Display
40 % OFF	Current Humidity Display Humidification function OFF		Humidification Stop Display Humidification Operation Display
1h 90°	Egg Turning Interval Indication Egg Turning Angle Indication		Water Supplement Humidity Abnormal
	PC Connecting Alarm		Power Failure Notification

SET UP(Other Functions)

► Push SET UP key and then select each function icon using UP/DOWN key(ENTER)

T.CAL Temperature Calibration		WARNING Fatal Damage with Incorrect Calibration!	Be sure to read CAUTIONS. We do not recommend customers to recalibrate by their own. If you need to recalibrate, please ask purchase place.
H.CAL Humidity Calibration		WARNING Fatal Damage with Incorrect Calibration!	Be sure to read CAUTIONS. We do not recommend customers to recalibrate by their own. If you need to recalibrate, please ask purchase place.
ALARM Abnomal High Alarm	High Temp HiErr	Alarm sounds when incubator temp. is higher than setting value because of room temp. change or heating system disorder * Setting Range : 0.0°C ~ 5.0°C (Default Setting : 2.0°C)	
ALARM Abnomal low Alarm	Low Temp LoErr	Alarm sounds when incubator temp. is lower than setting value because of room temp. change or heating system disorder * Setting Range : 0.0°C ~ -5.0°C (Default Setting : -3.0°C)	
Unit		Selecting Centigrade (°C) and Fahrenheit (°F) * Default Value : Centigrade (°C)	
Light		LCD Backlight management setting * Always On : Always BackLight On * Always Off : Always BackLight Off * Event On : 20 Sec. ON with Key input * Default Value : Always On	
Sound		ON/OFF Setting for Melody, other alarms * Default Value : ON	
ALL RESET Factory setting	ALL RESET	It returns to factory setting when you change the initial setting at discretion.	
Info		Basic information of Incubator (versoin Indication)	

Easy Function Operation

※ put some water after take off label from the back and attach to the window.
※ If you want to change setting value, keep pressing "SET" button and change the value.

Function	How to Operate	Page
Automatic Mode Incubation	► Select the Species of Bird ► 2 Sec.	13
Other(Manual) Mode Incubation	► Select the Species of Bird ► ► Temp. Setting Humid. Setting Egg Turning Angle Setting Egg Turning Interval Setting(Incubation day) ►	14 ~ 16
How to change Setting under Incubation	Once: Temp. Setting 4 times: Humidity Setting 7 times: Egg Turning Angle Setting 9 times: Egg Turning Interval Setting ► ►	18
Incubation Termination	Screen on Incubation ► System finish Are you sure? Select YES ►	17
Incubator Initialization (Factory Setting)	► "All Reset" ► ►	17
°C ↔ °F How to change	► °C ► ► °C ↔ °F ►	17
How to turn off Humidification Function In case of low humidity incubation	Screen on Incubation 4 times ► "OFF" ►	18
Egg Turning Test	5 Sec. Setting Value Check	18

How to Assemble

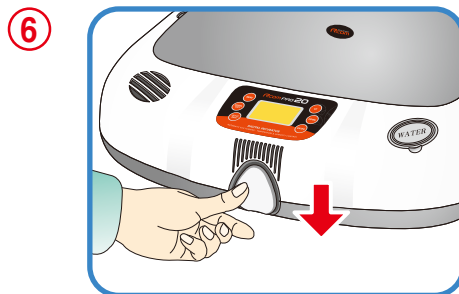
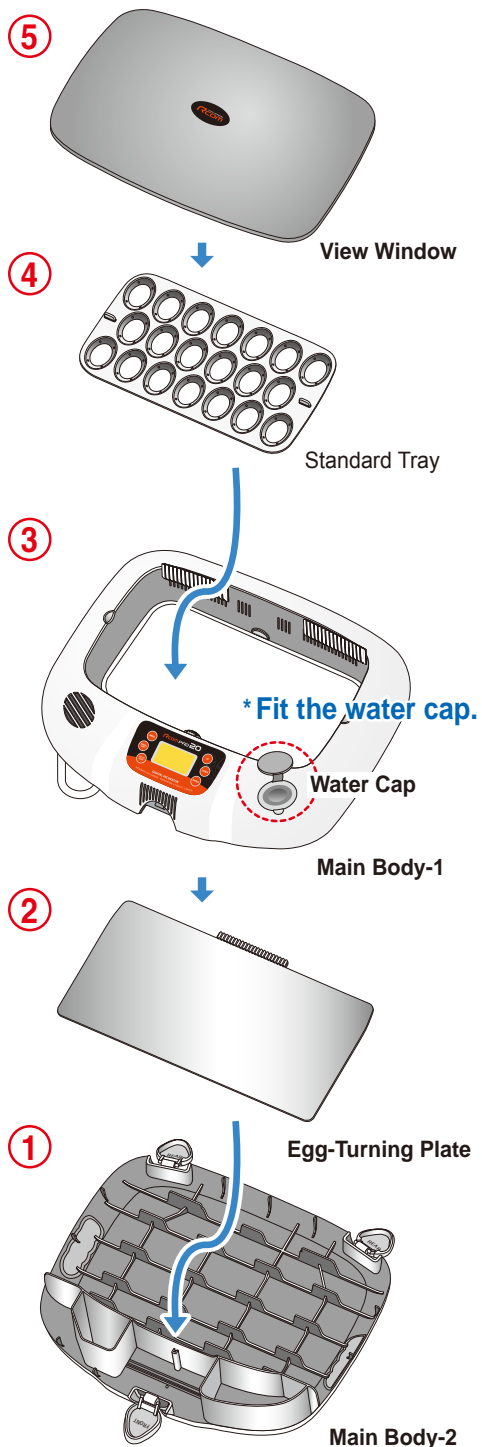

▶ Lock the three locking buttons at the front and rear of the incubator.

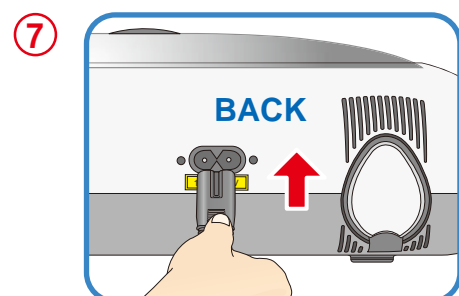

▶ Insert the power cord in the socket at the back of the main body.

⚠ Be careful when you assemble egg turning plate.

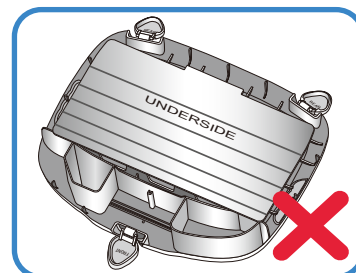
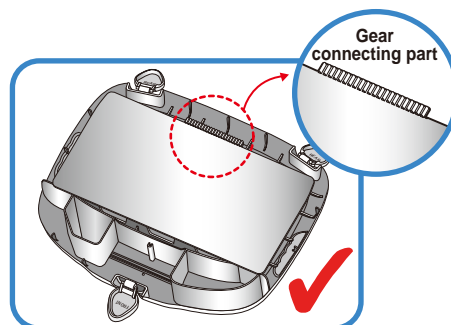

▶ If you do not assemble egg turning place correctly, it can cause incubator failure.

▶ Gear connecting part of egg turning plate must be on the top side.

What's an Incubation Room? / Preparation for Incubation

The Incubation Room is a confined space for setting and operating an incubator. Because the incubation room environment has a considerable effect on hatch rate, it's recommended to control the environment for setting up an incubator; there should be little noise and vibration around and temperature ranging 28°C (82.4°F) with small variation in temperature. Especially, if there are frequent occasions when the temperature drops suddenly at night, compared with daytime, be sure to check from time to time and pay attention so that the incubator is not directly exposed to sunlight during daytime.

- 1 Insert the electric cord in the connecting jack in the back of the main body and put the main plug into a socket. The LCD display will light up and show temperature.
- 2 Open the watercap and fill the hole with DISTILLED WATER and refill water after about 5 min. again up to the limit line on its inside mark. (If you refill water during the incubation period, humidity goes down temporarily.)

! After filling up with water, never shake or turn over the main body of the incubator, which would cause water to spill inside the body and could cause a breakdown.

Tip During incubation period, check the DISTILLED WATER water level about every three days and refill water, if necessary. (After you refill water, check again after 5min. and refill again.)

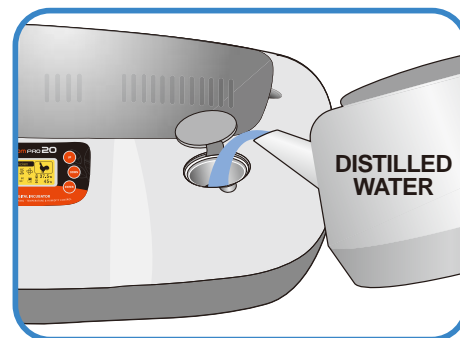
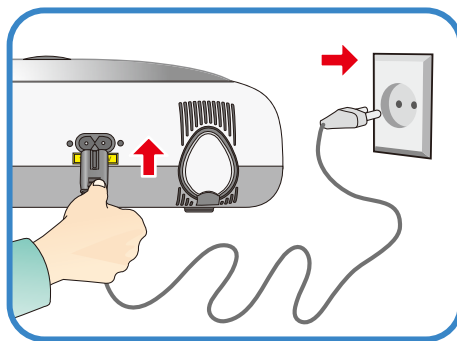

! In case you use the incubator without adding humidification water or intend to incubate eggs at low humidity under RH 30%, you must stop its humidification function. please turn off the humidity unit if the unit is empty water otherwise, humidity unit will be broke or you may not no longer use the unit. (When using this function, the alarm for sensing water drop will go out.)
[See the description of humidification function OFF on Page 18]

※ How to turn off Humidification Function : Set humidity level at RH 30%.

2. Before use

(2) What is an incubation room? / Preparation for Incubation

20

⚠ Some gap (about 2mm) around the eggs is needed for easy egg turning as shown on the below. ▼

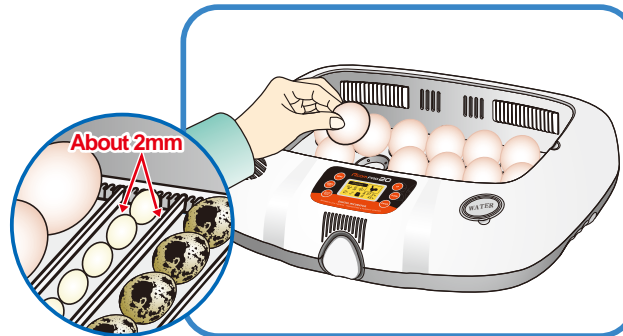

※ When you use the 'universal rolling divider' which is sold separately, be careful to adjust the distance of rolling divider so that eggs do not roll out of position. Refer to the picture right side.

⚠ If you use Mineral water or Tap water for humidification, the humidity unit can be broken easily because of water scales. We strongly recommend you to use only "DISTILLED WATER" for your machine, and Autoelex Co.,Ltd & our distributors do not indemnify for warranty service not only if you have any problem with using mineral water, regular water, tap water and the like but also if you had improper management or handling for your machine. In this case, Autoelex Co.,Ltd. & our distributors will charge for your after service.

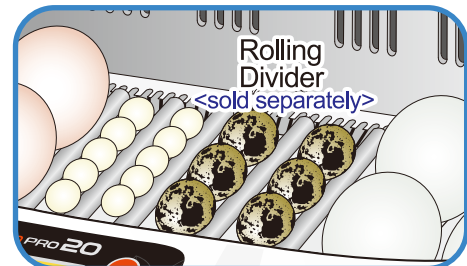

Tip You can buy the 'Distilled water' in your local market, and if you have any question, please contact the shop, where you purchased your machine.

3 Place the eggs to incubate in the egg groove and then close the view window.

⚠ Be careful to close the view window completely; if not, the temperature and humidity will fail to go up.

Tip The egg to incubate must be a fertilized egg. (Refer to the guidebook.)

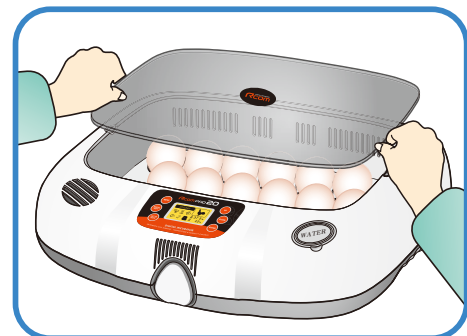

Incubation Modes

* Rcom Pro 20 incubator has two modes as automatic and manual mode, and Rcom USB 20 incubator has three modes as automatic, manual, and PC connecting mode.

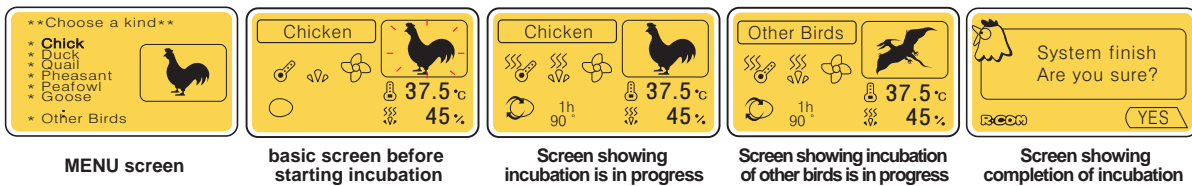
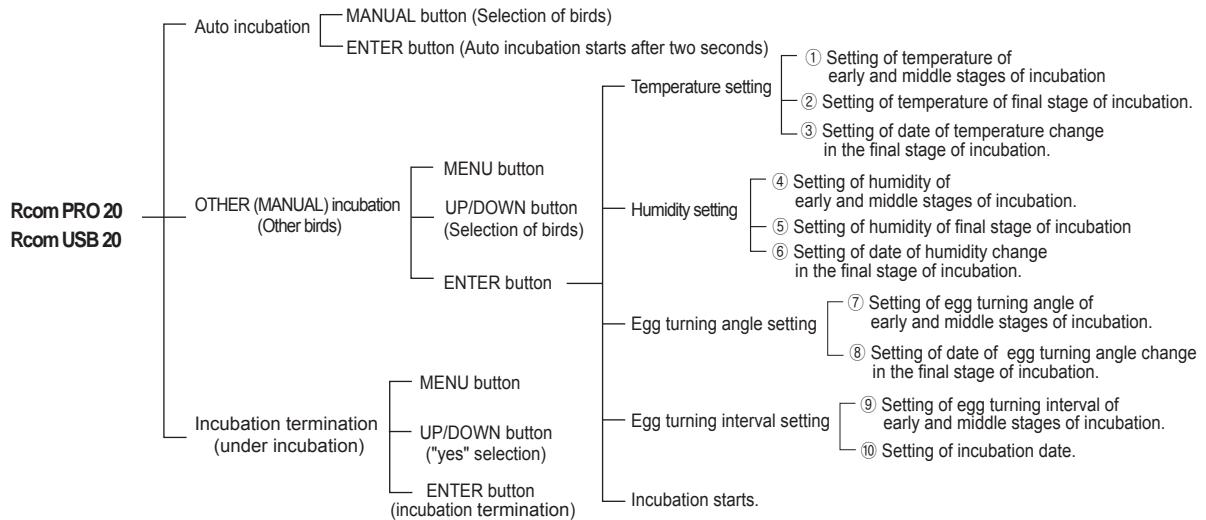

Incubation start with Automatic Mode

The optimum incubation environment of the birds on the menu screen is memorized in the micro chip. User can incubate easily using this function.

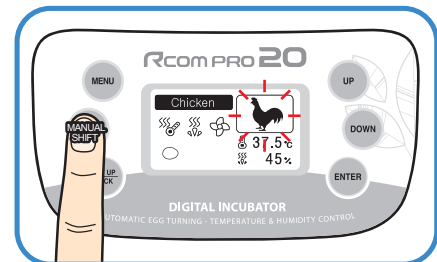
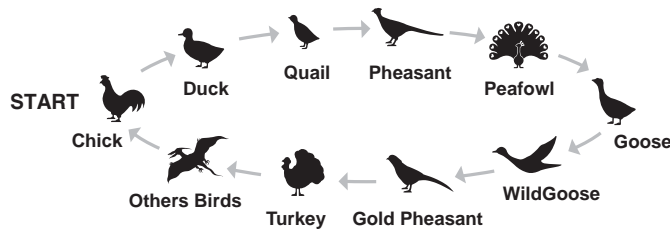

- ▶ Press MANUAL button to select species of birds in basic screen.
- ▶ Select species of birds and press ENTER button for about 2sec. then it starts incubation with automatic mode.

Tip In auto incubation, user only needs to select type of birds as incubation environments such as optimum temperature, humidity, egg turning, etc. are automatically controlled. User can change incubation environments if needed.



Incubation start with Manual Mode

This mode helps users to set temp. humidity, and egg turning etc. according to their needs. This mode is ideal for those persons who are experienced in incubation.

- ▶ Press MENU button on basic screen.
- ▶ Select the species of birds with UP/DOWN button and press ENTER button then it goes to incubation conditions setting mode.
- ▶ Set required temp. humidity, and egg turning angle & interval with UP/DOWN button, and press ENTER button to pass to next step.

Tip If there is no proper option, please select option other bird, Refer to Page16.

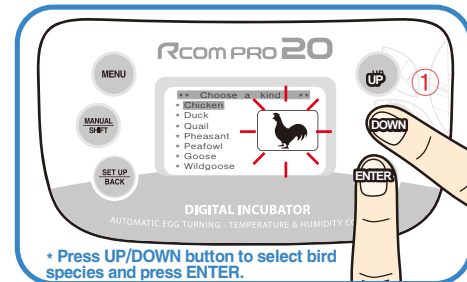
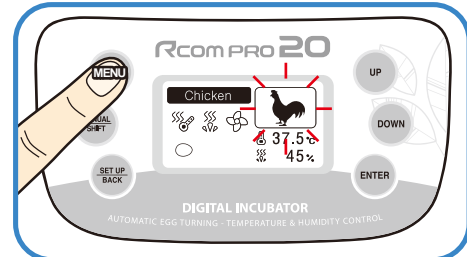

STEP1 Temperature setting

- ① Setting of temperature of early and middle stages of incubation.
- ② Setting of temperature of final stage of incubation.
- ③ Setting of date of temperature change in the final stage of incubation.

▶ Optimum incubation temperature of general birds at early and middle stages ① is 37.5°C, and the temperature of final stage ② is better to set at 37°C three days before the expected date of hatching (D-Day) ③. User can optionally change the temperature of early, middle, and final stages of incubation. (Default settings: ① 37.5°C, ② 37.0°C, ③ 3days)

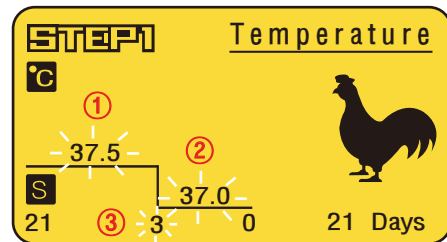

[Temperature Setting]

STEP2 Humidity setting

- ④ Setting of humidity of early and middle stages of incubation.
- ⑤ Setting of humidity of final stage of incubation
- ⑥ Setting of date of humidity change in the final stage of incubation.

▶ The optimum humidity depends on type of birds. However the humidity of final stage ⑤ (3 days before incubation) is generally higher than that of early and middle stages ④ of incubation. (Default settings: ④ 45%, ⑤ 60%, ⑥ 3days)

Tip It is recommended to raise the humidity setting to over 60% from 1~3days before hatching. (In areas of high ambient humidity, the humidity may not need to be raised until the last half day - after the chick is into the air space at the end of the egg.)

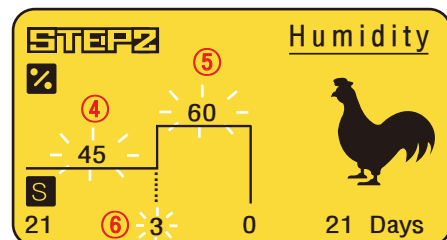

[Humidity Setting]

Tip Temperature and humidity is optimized when Rcom products are released. We do not recommend customers to recalibrate by their own. If you need to recalibrate, please visit our website (www.RcomCo.com) or ask purchase place. Because of low price thermometers and hydrometers are not accurate, we recommend you to use special calibrated thermo-hydrometer. (Poultry only thermo-hydrometer: check Rcom website: Digilog II)

STEP3 Egg-turning angle setting

⑦ **Setting of egg turning angle of early and middle stages of incubation.**

⑧ **Setting of date of egg turning angle change in the final stage of incubation.**

▶ The egg turning angle showing on LCD screen may be different from the setting angle depending on egg tray (based on standard egg tray) and size of eggs. In general, the egg turning angle of early and middle stages is 90° for chicken, golden pheasant, pheasant. It is better to set higher angle (110 ~180°) for bigger eggs and wild birds. It is a general practice not to turn eggs (turn angle is 0°) at final stage of incubation (3 days before expected hatching date).

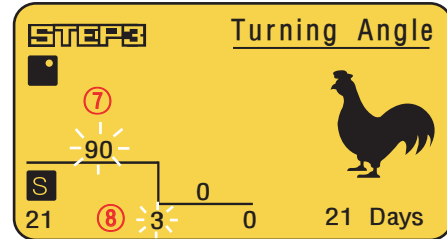

[Egg Turning Angle Setting]

Tip When "rnd" (Random) is set, the egg turning angle is between 75~180° at random. (Egg turning angle setting range : 0°, 15°, 30°, 45° , 150°, 165°, 180°, rnd)

! If having difference for the egg turning angle between display and actual operating, Please find and select the proper angle.

STEP4 Egg turning interval setting

⑨ **Setting of egg turning interval of early and middle stages of incubation.**

⑩ **Setting of incubation date.**

▶ It is a function to set the interval (time) of egg-turning ⑨. It turns the eggs with the setting angle of early and middle stages ⑦ every 60min. User can optionally set the egg-turning interval ⑨ of eggs. (Initial Setting: ⑨ 60min.)

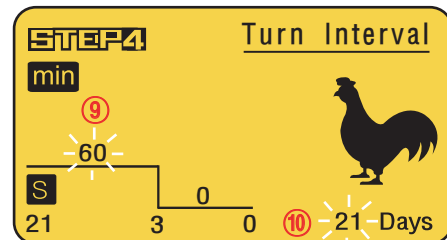

[Egg Turning Interval, Incubation Date Setting]

Tip "rnd"(Random) setting is for operating at random within the limits from 10min. to 360min. (Egg turning interval setting range: rnd, 10, 20, 30, 40 340, 350, 360min.)

▶ Setting of incubation date: The incubation date of birds on menu screen is a general incubation date. User can input the correct incubation date. (Initial settings: depending on type of birds)

※ Incubation date setting cannot be changed during incubation.

[Setting Finish and Incubation Start]

▶ After setting incubation date, press ENTER button to start incubation with melody.

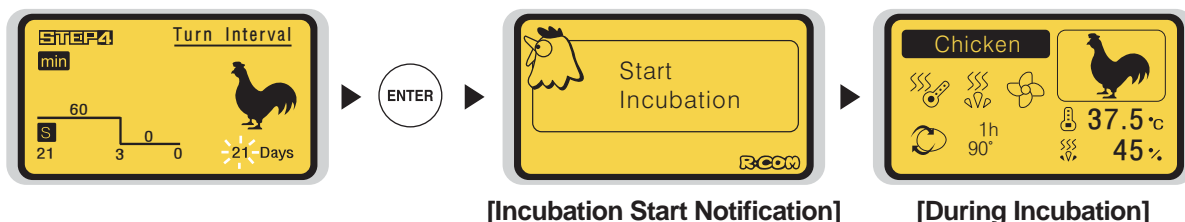

3. Function Settings

(3) Incubation Start for Other Birds

20

Incubation Start for other birds

This function is used when user wishes to incubate other birds which are not memorized in the incubator menu setting. User can change incubation conditions according to needs.

- ▶ Press MENU button in basic screen.
- ▶ Select Other Birds by UP/DOWN button and then press ENTER to go to setting.
- ▶ Set incubation date, temperature, humidity, egg turning angel and egg turning interval with UP/DOWN button, and press ENTER button to save setting value.
[Refer to the page 14, 15]

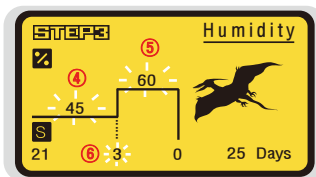
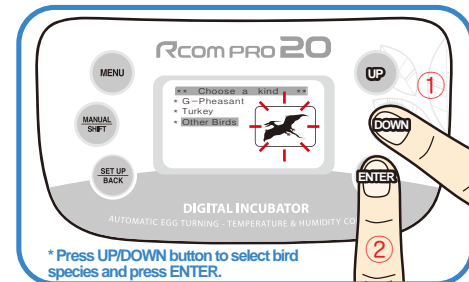
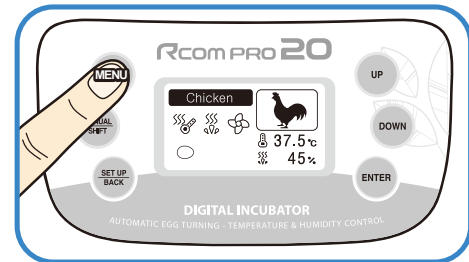

[Humidity Setting]

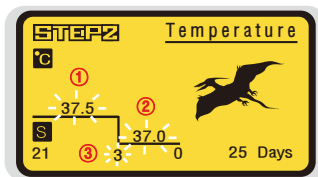

[Temperature Setting]

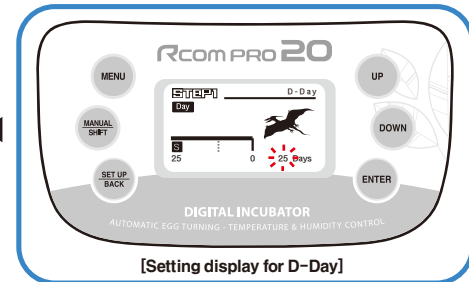

[Setting display for D-Day]

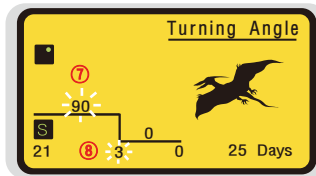

[Egg Turning Angle Setting]

▶ **How to Set Consecutive Incubation Function:** On Incubation date setting, raise incubation date up to D-50 and then press UP button one more, then "?" will be show and it starts Consecutive incubation.



What is Consecutive Incubation Setting?

This function is used if you want to continue incubation without termination with same setting.

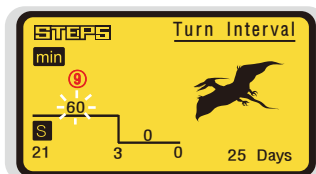

[Egg Turning Interval, Incubation Date Setting]

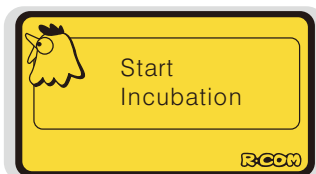

[Incubation Start Notification]



[During Incubation]

Incubation start with PC connecting mode

<Rcom USB 20 MODEL ONLY>

With this function, you can share incubation process, optimum incubation setting by building a database.

- ▶ Refer to the PC Software Manual for starting incubation in PC connecting mode.

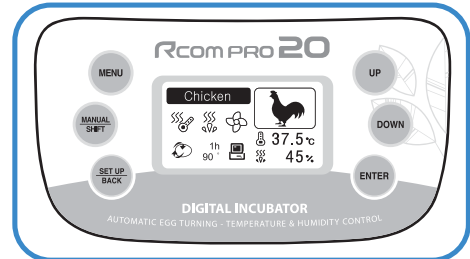

Incubation Termination

- ▶ During incubation, press MENU button then you can see a message as "System finish, Are you sure?"
- ▶ Select YES with UP/DOWN button and press ENTER.

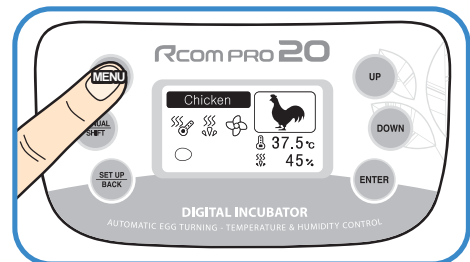

Change Cels. & Fahr.

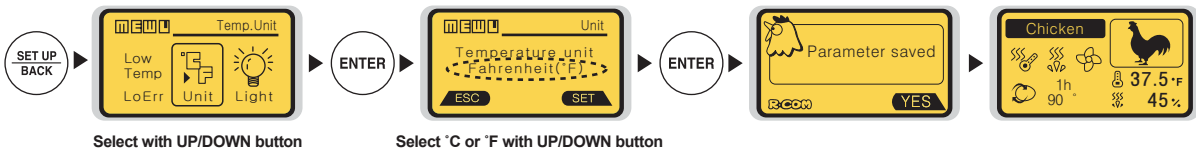

Return to factory setting

- ▶ When users have changed the incubator settings, but want to return to factory setting.
- ▶ Press SET UP button and select All Reset with UP/DOWN button. Then, press ENTER. If you press ENTER button once again, LCD display goes off with message & alarm. Incubator returns to factory setting after about 15 sec.

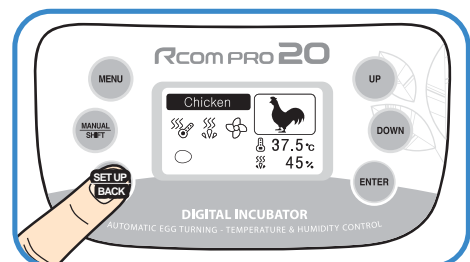

Initialization after about 15sec.

3. Function Settings

(6) Incubation conditions reset /
How to Set Egg Turning Test /
Turn ON, OFF Humidification Function

20

Incubation Condition Reset during Incubation

- ▶ This is used when you want to change incubation setting mode again during incubation. Press MANUAL button during incubation, then Temp. display will blink. If you want to change Temp. reset with UP/DOWN button and then press ENTER to save. Using this method, you can also reset humidity, egg turning angle, and egg turning interval. If you do not want to change setting, just press MANUAL button then it passed to next stage. Also, it returns to incubation screen if you do not press any key for about 10sec.

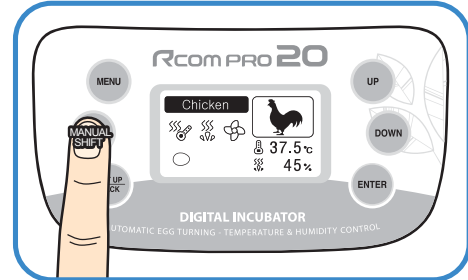

- ▶ You can go directly to the needed setting mode by pressing MANUAL button several times according to your needs. It can be used when you want to check the current incubation condition during incubation.
- ▶ If you press ENTER button, LCD display indicates setting Temp. & Humidity.



[Setting Save Message]

Egg Turning Test

- ▶ Press ENTER button for about 5sec. during incubation period to check egg turning.
- ▶ If egg turning does not work, check whether you assembled the egg turning plate properly. [Refer to the page 10.]

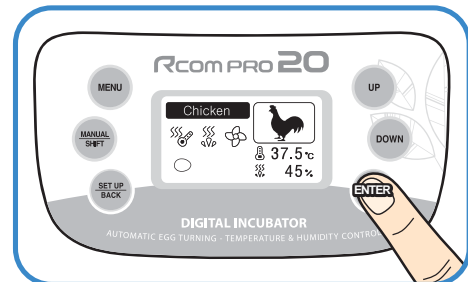

Humidification Function ON/ OFF Setting

- ▶ You should turn OFF humidification function when you operate incubator without water, or when you want to incubate with low humidity below 30%.
- ▶ Press MANUAL button 4 times and then press DOWN button continuously until OFF indication is showing. Then, press ENTER button to turn humidification off. If you want to humidification turn ON, set humidity over 30%

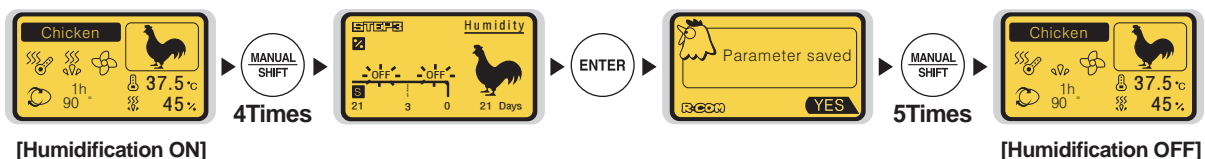

Egg Turning Check Function

- ▶ When starting egg turning, animation showed on display with melody.



Water Shortage Detecting Function

- ▶ When water is short, humidification icon is changed → and water supplement alarm sounds after 5 min. This alarm continues every 30 sec.

! It takes about 1min. to return to normal display after you refill water.

- ▶ When there is any problem on water detecting sensor, humidification icon is changed like this → , and alarm sounds with message.

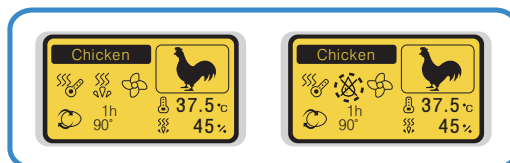
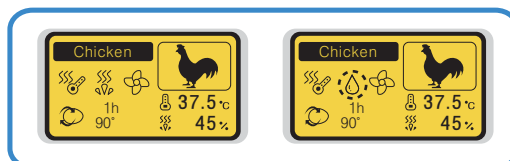

Abnormal High or Low Temperature Alarm Function

- ▶ When incubator temperature is different from setting value, icon is changed → , and display indicates current temp. and temp. difference alternatively.

***** Alarm call automatically turned off after 1min. but you should press ENTER button to switch off alarm indication.

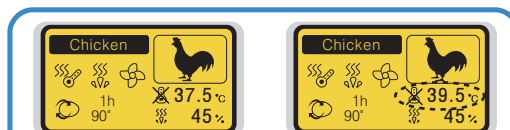

<Example>
 When temp. difference is 2°C, it indicates 39.5°C and +2.0 alternatively (setting 37.5°C)
 When temp. difference is -3°C, it indicates 34.5°C and -3.0 alternatively (setting 37.5°C)

*** How to Set Abnormal High Temp. Setting (When incubator temp. is higher than setting temp.) [Setting Range: 0 ~ 5°C, Default Setting : 2°C]**

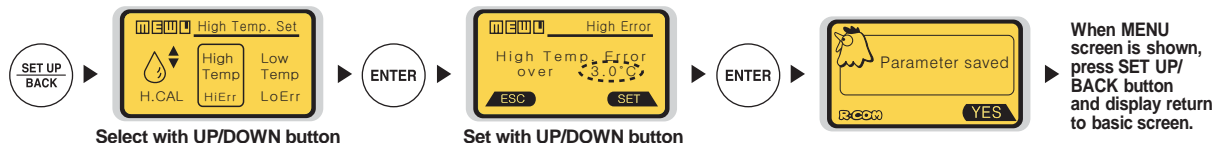

*** How to Set Abnormal Low Temp. Setting (When incubator temp. is lower than setting temp.) [Setting Range: 0 ~ -5°C, Default Setting : -3°C]**

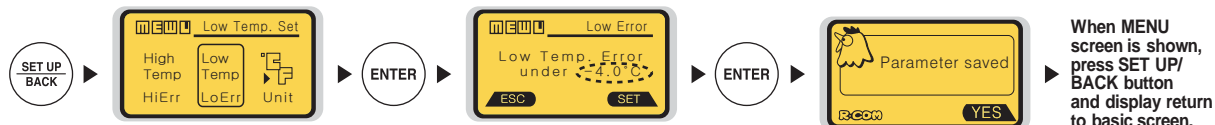

Power Failure Alarm Function

- ▶ When you first switch on the power, or in case of power failure during incubation, display shows this icon and incubator and incubator alarm sounds for about 10sec. Press ENTER to remove.

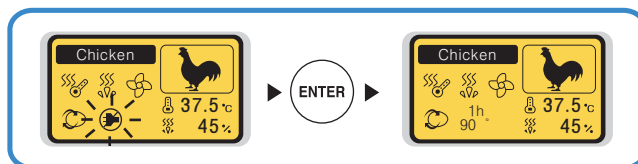

5. Incubation

(1) Humidity & Air Maintenance during Incubation /
Maintenance after Hatching
(2) Dew Condensation

20

Humidity & Air Maintenance During Incubation

- ▶ When hatching, humidity should be relatively high to prevent the thin membrane from drying out or hardening before hatching.
- ▶ When hatching, it's recommended not to open the lid often. This is because if you open the lid often humidity will be rapidly decreased and it will take a long time to regain the proper humidity.
- ⚠ **Incubator internal temperature is 37 °C (99.5°F) or more, and hatching room temperature is below 28 °C, in that case, RH 70% humidity is may not be able. The difference of ±5% humidity value may occur from the humidity sensors difference, and there are no problems at hatching**
- ▶ It's very important to maintain humidity higher 1~2 days before hatching than the early and middle incubation periods. Humidity requirements during incubation are RH 45~55% for waterfowl, RH 40~45% for poultry and RH 35~45% for parrot, in general. One day before hatching, all kinds of birds need about RH 65% humidity and sometimes need higher than that. However, in areas of high ambient humidity, lower levels of humidity may be needed during incubation.

Tip It's very important to keep humidity higher than RH 60% before hatching 3days.

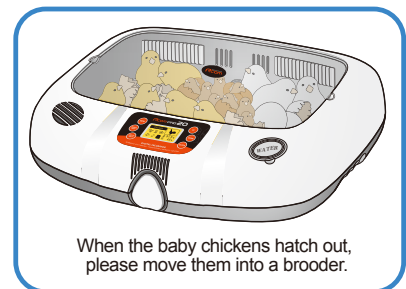
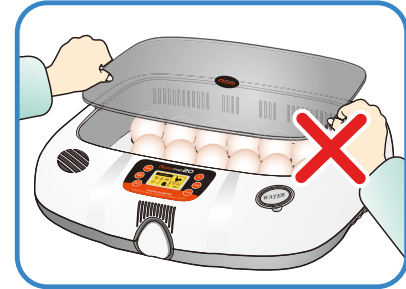

Maintenance after Hatching

- ▶ It is necessary to use a brooder for baby chicken or bird since they are too week against cold or cool environment. If you try egg-hatching in your incubator, there would be lots of germs, feathers, which causes of low egg hatching possibility for your next hatching. Also, they can make your incubator broken or faulty. We strongly recommend you to use independent Hatcher or Brooder for egg-hatching. If you have any faulty or broken because of not using independent Hatcher or Brooder, we do not serve you the free warranty service. In other words, you have to pay for the service charge.
- ⚠ **Please do not try to egg-hatching in the incubator. It makes your incubator broken or faulty, and we do not give you free warranty service. (Please move all the eggs 1~3 days before hatching into Hatcher or Brooder.)**
- Tip** Hatcher : The machine for egg-hatching. Operate it 1~3 days before egg-hatching. (Rcom MARU H&B)
Brooder : The machine makes baby chickens or birds warm up against cold or cool environment. You can set up proper temperature and humidity. (Rcom MARU H&B / Rcom Brooder Series)
- ▶ As there is some difference in chick feed for each kind of bird, so it's desirable to obtain useful information about the chicks before hatching.

- ⚠ **Be sure to use a three-wavelength 20W bulb. If you use a bulb over 20W. temperature goes up, possibly killing the chick or causing a fire. If there is too much water and a chick would falls into water, its feathers get wet and it can be died of loss of body heat. Here, dry feathers with a hairdryer. etc**
Be sure to use a three-wavelength 20W bulb :
In case breeding room size 370 x 270 x 130(mm)

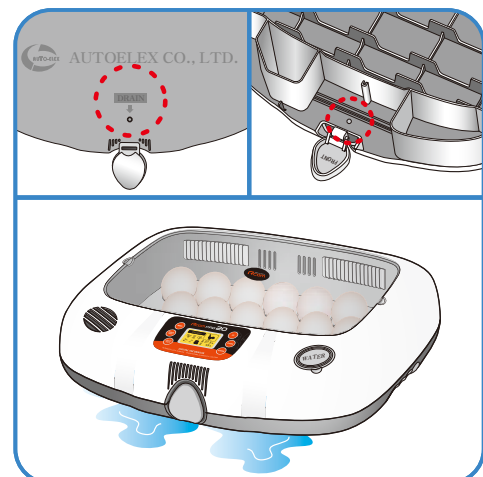

Dew Condensation

This is a naturally occurring phenomenon when there is a significant difference in temperature between inside and outside of the incubator during incubation period. If this occurs, water may form in inside bottom of the main body of the incubator(bottom part).

- ▶ Pull out the electric cord from the connecting jack and also take out the plug from the outlet.

! Don't turn off the power soon after using the incubator, as this may cause a break down due to moisture left inside the main controller. At this time, it's better to firstly remove the water inside of the incubator and dry by operating it for 1hour and then turn it off or open the view window and dry it naturally for 2~3 hours and, then, re-operate it, which may lengthen the life time of incubator.
(Set humidification function OFF. / Refer to the page 18)

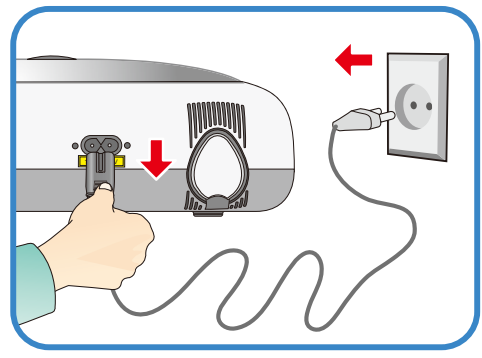

How to disassemble and clean the incubator

1

Unlock and remove the locking buttons for three parts at the front and back of incubator by pulling them forward.

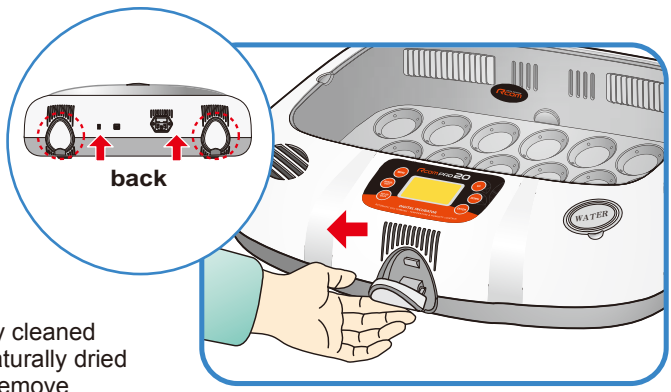

2

The bottom part of incubator should be thoroughly cleaned with water and dried. The upper part should be naturally dried in the well-ventilated place for about one day to remove moisture left inside of the incubator after hatching thoroughly.

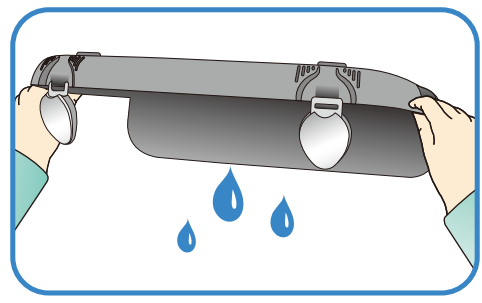

! Don't clean the product with organic solvents such as benzene, thinner, etc. which may cause deformation or decoloration of the plastic parts.

3

- ▶ When using humidification function, a lot of alien matter sticks to the humidification heating element (a). This may not cause failure, but when terminating incubation please clean the humidifying heater lightly with a soft brush.
- ▶ If you place the main body(upper part) on the floor, please don't let the humidification heating part touch with the floor.

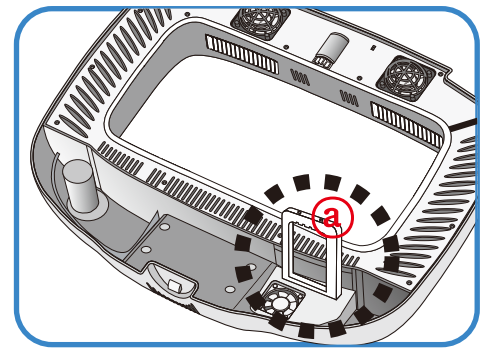

! If you inflict impact on the humidification heating part or scrape it with a sharp instrument, the humidifying heater will be damaged.

! We kindly recommend you to use distilled water In order to reduce a foreign substance on the humidifying heater device.

6. How to Clean

(2) How to Clean

20

4

Start the vacuum cleaner to remove the dust as shown on the right and thoroughly shake out the minute dust with a fine brush.

Tip If the incubator goes through incubations several times, feather, dust, shell, etc. accumulate inside the main body, which may cause a break down, so be sure to clean the product before storage.

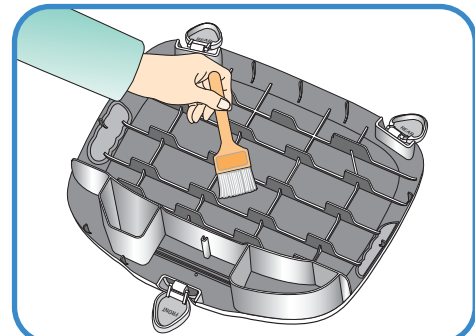

! In case the incubator clean status is poor which may cause fan noisy or stopping.

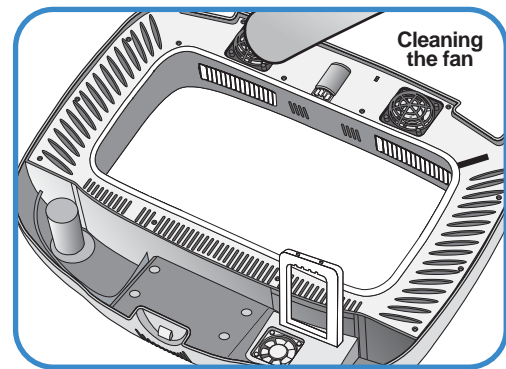
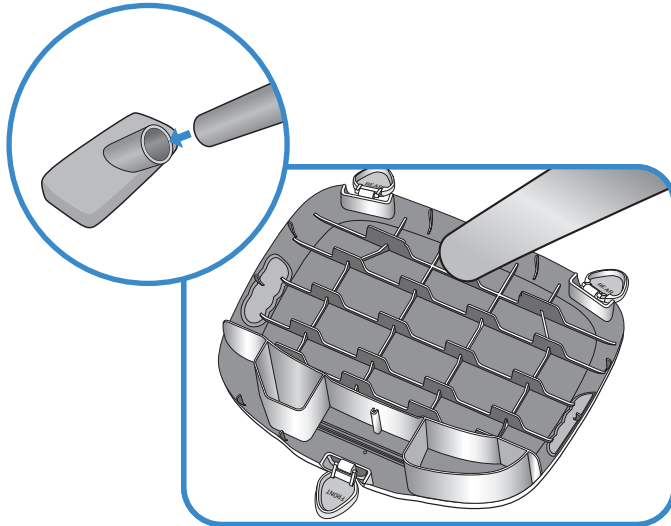

5

If you finish cleaning the incubator, reassemble it in the reverse order of disassembly. Wipe out outside the main body with a wet cloth and dry it in a cool and well-ventilated place before storage.

Tip [Refer to How to assemble on Page 10.]

! Don't clean the product with organic solvents such as benzene, thinner, etc. which may cause deformation or decoloration.

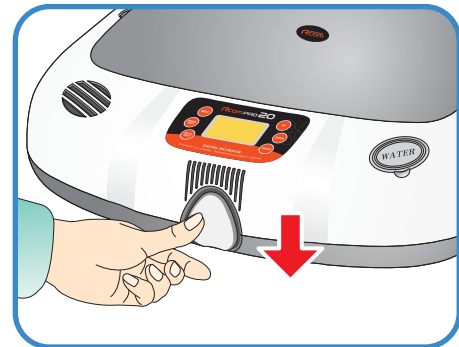

Servicing

All our Rcom digital incubators of Autoelex Co., Ltd. are made by precision systems under strict quality control. But occasionally some defective products are found on the way of their distribution. If any problem occurs, then please contact Rcom service center or distributors in your country. We will do our best to solve the problems, if any, for you. This product is designed in modular mode, so for its repair, if any, a qualified person can replace the part concerned with ease.

Frequently Asked Questions (FAQ)

Troubles	Expected Causes (Possibility)	Countermeasures
In case hatching rate is low	<ul style="list-style-type: none"> ▶ When the egg is an unfertilized egg. ▶ Getting infected by germs ▶ Wrong incubation setting ▶ Health condition of mother bird ▶ Improper egg turning 	<ul style="list-style-type: none"> ▶ Inspect the egg to check possibility of egg surviving. ▶ Disinfect the incubator. ▶ Check all settings of incubator. Especially, check them focusing on the temperature. ▶ Review care of health of mother bird. ▶ Check if egg turning is normal.
When a chick hatches out earlier than expected or a deformed chick hatches out	<ul style="list-style-type: none"> ▶ Setting temperature high ▶ Egg turning was not operating normally 	<ul style="list-style-type: none"> ▶ Lower temp. setting of the incubator about 0.5°C (1°F) ex) 37.5°C (99.5°F) → 37.0°C (98.6°F) ▶ Check if egg turning function is OFF
When a chick hatches out later than expected	<ul style="list-style-type: none"> ▶ Setting temperature low 	<ul style="list-style-type: none"> ▶ Raise temp. setting of the incubator about 0.5°C (1°F) ▶ ex) 37.0°C (98.6°F) → 37.5°C (99.5°F)
When hatching dates are so different from each egg (When all chicks don't hatch out at the same time but over a long period)	<ul style="list-style-type: none"> ▶ Eggs stored for different lengths of time ▶ Different incubation temperatures 	<ul style="list-style-type: none"> ▶ Minimize the time to store egg properly. ▶ Check Temperature difference in the incubator. (sunlight, temp of incubation room, etc.)
When intending to hatching various eggs at the same time	<ul style="list-style-type: none"> ▶ Incubation days are different, so hatching rate falls down. ▶ Eggs might be contaminated by chicks that hatched first. 	<ul style="list-style-type: none"> ▶ Mark hatching date on eggs and move them to other incubator (brooder) just on the marked date. ▶ In case of putting in many eggs at the same time, it's convenient to prepare a spare incubator available as a brooder

Troubleshooting

If you need detail self diagnosis, please click "self diagnosis" on our website.

CIRCUMSTANCE	ITEMS TO BE CONFIRMED	SOLUTIONS
No signs of power to the incubator.	<ul style="list-style-type: none"> ▶ Check electric cord is properly connected. ▶ Check if there is a power outage. ▶ Check whether the plug is damaged. 	<ul style="list-style-type: none"> ▶ Connect the cord again. ▶ Check the main socket with any other electric appliances. ▶ Try to insert to another outlet.
Temperature will not go high enough.	<ul style="list-style-type: none"> ▶ Check your setting temperature. ▶ Check the air circulation FAN is working. ▶ Initialize the incubator. [Refer to the page 17] 	<ul style="list-style-type: none"> ▶ Set the temperature as required. ▶ Take the power plug out of the outlet, and disassemble the main body for cleaning around the air circulation fan with brush.
Alarm sounds with HI indication (abnormal high temp.)	<ul style="list-style-type: none"> ▶ Check if room temperature is too high ▶ Check if incubator is exposed to the direct rays of sun 	<ul style="list-style-type: none"> ▶ Adjust room temperature 28°C (82.4°F) ▶ Install incubator without the direct rays of sun ▶ Return incubator to factory setting [Refer to page 17]
Alarm sounds with LO indication (abnormal low temp.)	<ul style="list-style-type: none"> ▶ Check if room temperature is too low ▶ Check if incubator heater(temperature controlling-system) is normally working 	<ul style="list-style-type: none"> ▶ Adjust room temperature 28°C (82.4°F) ▶ Place thermometer inside of incubator and check if setting temperature is correct ▶ Return incubator to factory setting [Refer to page 17]
Humidity will not go high enough.	<ul style="list-style-type: none"> ▶ Check your setting humidity. ▶ Close the view window again after checking. ▶ Initialize the incubator. [Refer to the page 9] 	<ul style="list-style-type: none"> ▶ Supply water. ▶ Set the humidity again as required.
The machine makes some noise. - It is normal that the machine emits some sounds because it uses air circulation fan for working.	<ul style="list-style-type: none"> ▶ Check if there is any hatching debris such as feather or eggs-shell in the incubator FAN. 	<ul style="list-style-type: none"> ▶ Take out the plug out of the outlet and disassemble the main body and clean around the air circulation fan with brush.
Egg-Turning fails to work.	<ul style="list-style-type: none"> ▶ Check that the Egg-turning stoppage is not activated. (Egg-turning lamp lighting) ▶ Check that there are no foreign items on the egg turning tray. ▶ Check if egg turning plate is assembled correctly. [Refer to the page 10] 	<ul style="list-style-type: none"> ▶ If you need to turn the eggs, you can manually re-start egg-turning. ▶ Unplug the power supply and disassemble the main body for cleaning the egg turning tray and gear. ▶ Assemble egg turning plate as the picture on page 10.
Dew foams in the incubator.	<ul style="list-style-type: none"> ▶ Check the incubator is not placed too cold circumstances. ▶ When you turn OFF incubator and then turn on. 	<ul style="list-style-type: none"> ▶ Move the incubator to where the ambient air temperature is over 28°C (82.4°F) ▶ Dew condensation is normal. ▶ Dry the incubator completely under well ventilated place.
Water leaks from the machine.	<ul style="list-style-type: none"> ▶ Check that you have not overfilled the incubator. ▶ Check that the incubator placed on inclined surface. ▶ Check if it is Dew condensation 	<ul style="list-style-type: none"> ▶ Do not fill water over LIMIT indication. ▶ Place incubator under a level surface.



Be sure that the incubator works without any problem before placing eggs in the incubator.









Specification

- 1-1 Name : Rcom USB 20 / Rcom PRO 20
- 1-2 Model : UX-20 / PX-20
- 1-3 Supporting Soft : Rcom USB 20
INCUBATION SYSTEM (WINDOWS)

Power	AC 100~120[V], 50/60[Hz] / 220~240[V], 50/60[Hz]	
Working Temp.	20 ~ 42.0[°C]	
Working Humid.	30 ~ 70[%]	
Power Consumption	Average. 48[W] MAX. 65[W]	
Capacity	10 ~ 52[EA]	
Weight	4.5 [Kg]	
Size	(W)500 * (L)410 * (H)160 [mm]	
Fuse Standard	250[V] 2.0[A] (Ø5×20[mm])	
Temp. Limits	Automatic	automatic setting for each birds (manual control available)
	Manual	20.0 ~ 42.0[°C]
	PROG (PC)	normal temperature ~ 45.0[°C]
Humid. Limits	Automatic	Automatic setting for each birds (manual control available)
	Manual	30~70[%] (It can be changed according to the conditions)
	PROG (PC)	30~70[%] (It can be changed according to the conditions)
Egg-Turning Interval		15[°]~ Different from the egg tray
Capacity		Small - 52 [EA] (Quail egg size) - Small egg tray Standard - 20 [EA] (Chick egg size) - Standard egg tray Large - 10 [EA] (Goose egg size) - Large egg tray For all size egg - Different from the species of egg Universal tray (option)
PC Connecting - USB MODEL -	USB 2.0	- Real - time hatching condition transmission and setting control - Incubator Upgrade

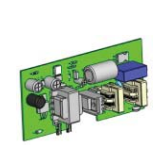
-  You will be asking for service charge if you are in below cases.
1. Broken or Problem caused by 'No cleaning' or 'Improper handling'
 2. Broken or problem caused by 'Not using distilled water'
 3. Broken or problem caused by 'Trying Bird hatching in incubator'
(Please don't try bird hatching in incubator. Please use Hatcher during bird hatching.)
 4. Broken or problem caused by 'Wrong controlling(Using)'
 5. Broken or Problem caused by using the machine out of User's Manual.
 6. Broken or problem caused by 'Customer's mistake or fault'

Rcom USB 20, PRO 20, MAX 20 PART LIST

Image	Part No	Names of goods (*.Compatible)	Image	Part No	Names of goods (*.Compatible)
	H20-F201-10	H20 Body		H50-H611-10	H50 Humi Heater Cover
	H20-A202-10	H20 Bottom ASM		H20-A216-10	H20 Humidity Unit ASM
	H20-F203-10	H20 Slide		RCM-700-10	Silicon Tube
	H20-A200-10	H20 Window ASM		K20-H512-10	Heat Support -A
	H20-A218P-10	H20 PRO Main PCB ASM		H50-H612-10	Heat Support- B
	H20-A218U-10	H20 Main PCB USB ASM		H20-A234L-10 H20-A234H-10	H20 Silicon 110HEATER ASM H20 Silicon 220HEATER ASM
	H20-A218M-10	H20 MAX Main PCB ASM		H20-AF212-10	H20 Front Lock ASM
	H20-A219-10	H20 SMPS PCB ASM		H20-AF211-10	H20 Rear Lock ASM
	RCM-A310-10	TH V2 Sensor ASM		H20-F240-10	H20 Air Fin
	H20-F206-10	H20 Main PCB Cover		H20-F229-10	H20 Water Cap

※ Some spare parts are not on the parts list.

Rcom USB 20, PRO 20, MAX 20 PART LIST

Image	Part No	Names of goods (*.Compatible)	Image	Part No	Names of goods (*.Compatible)
	H20-F237-10 (Option)	H20 Brooding Tray		H20-F219P-10 (R90-F219M-10)	H20 PRO Membrane SW (R90 Pro type)
	H20-F210-10	H20 Universal Tray (*For reptile incubator)		H20-F224-10	H20 Pinion Gear
	H20-F233-10	ABS Divider(No.2)		H20-F223-10	330 Geard Motor
	H20-F234-10 (option)	H20 Roller Divide		H20-F214-10	Humi BLDC FAN40
	H20-F208-10	H20 Standard Tray		H20-F226-10	BLDC FAN50
	H20-F207-10	H20 Large Tray		H20-304XX-10	Power Coard(8)
	H20-F209-10	H20 Small Tray		H20-H686-10	H20 Rubber Foot
	H20-F219M-10 (R90-F219M-10)	H20 MAX Membrane SW (R90 Max type)		H20-F239-10	H20 Styrofoam Ball
				H20-F244-10 (Option)	H20 Hatching Pad
				RCM-347-10	USB Cable

※ Some spare parts are not on the parts list.

Rcom is designed for user's easy and convenient use.
It can be changed without notice for improvement in performance,
design,treatment, and software, etc.



<https://www.R-com-hatcher.com>



North America Sales & Service

<https://www.R-com-hatcher.com>

MANUFACTURER

AUTOELEX CO.,LTD.

● Head Office : Deokam 612 Juchon Gimhae

Rcom is the Best Design with High Quality, Value, and Performance!